



9th International Conference on
MANAGING PAVEMENT ASSETS (ICMPA9)

Latest Development in the Processing of Pavement Macrotexture Measurements of High Speed Laser Devices

Daniel E. Mogrovejo
Samer W. Katicha
Gerardo W. Flintsch
Edgar D. de León



Outline

- Background
- Problem statement
- Objective
- Research approach
- Results
- Conclusions

Background

Texture Wavelength Influence on pavement surface characteristics

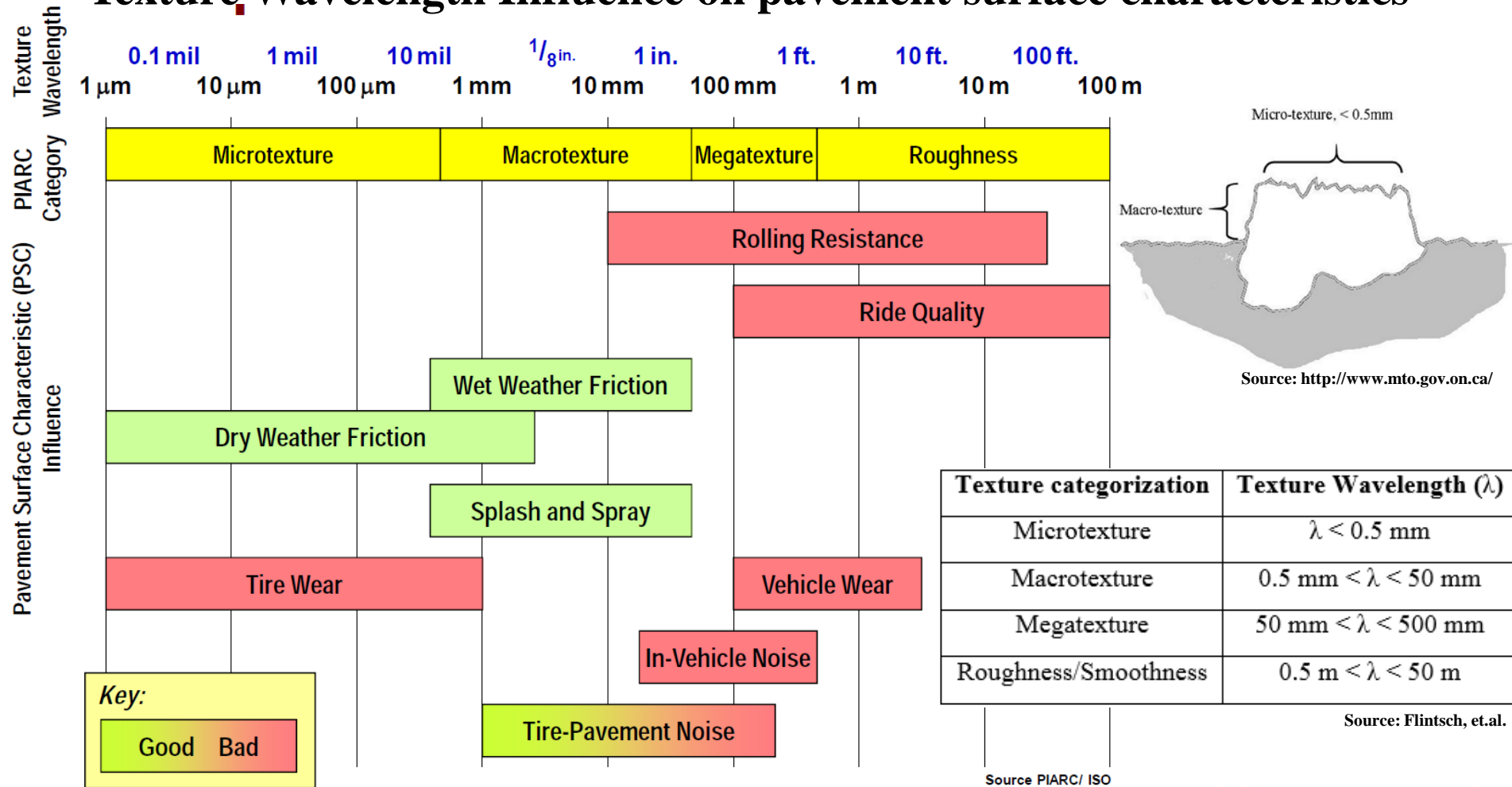

Background

- Texture
 - Adequate surface macrotexture of a pavement is essential to:
 - provide good skid resistance,
 - Efficiently drain water out of the contact area,
 - Reduce splash and spray,
 - Mitigate tire-pavement noise, among other properties

Background

- **Methods**

CTmeter

Mean Profile Depth (MPD), Root Mean Square (RMS)

ASTM E2157-09

Static. Profile

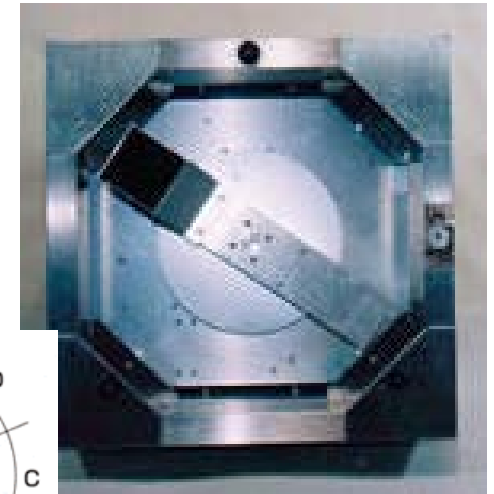
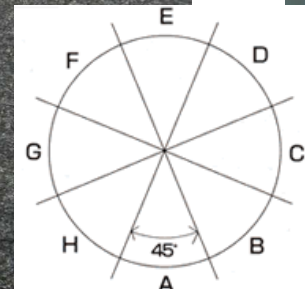

<http://www.tics.hu/CTMeter.htm>

Background

- **Methods**

High frequency laser devices

MPD, RMS

ROLINE, AMES, etc.



www.amesengineering.com

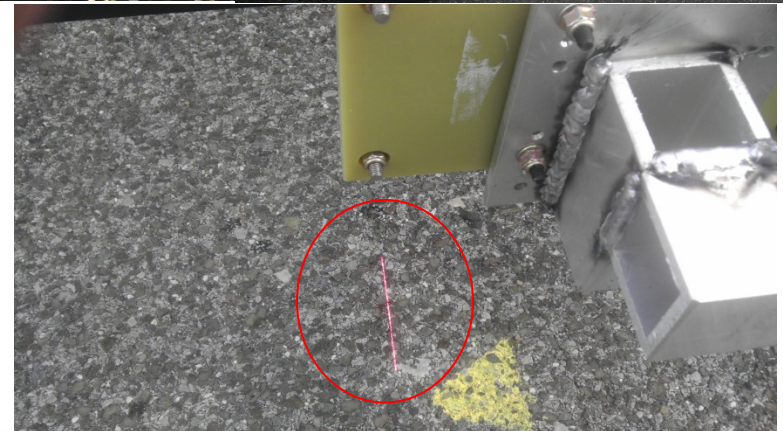

Problem Statement

- A drawback of laser devices is the presence of “spikes” in the collected data. These spikes make measurements inaccurate and cause erroneous calculated texture (mean profile depth) values. Therefore, identifying and removing these spikes is essential to obtaining accurate MPD measurements.

Objective

- (a) Develop a method that can objectively identify and remove the spikes
- (b) Compare the results of the calculated MPD with and without spikes
- (c) Validate the method with MPD measurements obtained with a Circular Texture Meter (CTMeter) taken at the same locations.

Research approach

- Test site: Section B on VA Smart road, SM9.5D

- Asphalt section,
- SM: Surface Mix
- H= 38 mm
- MSA: 9.5mm
- D: 70-22

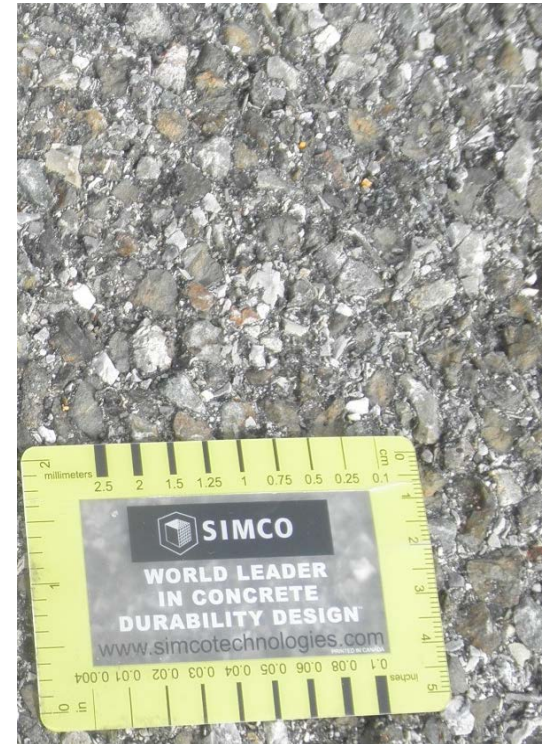
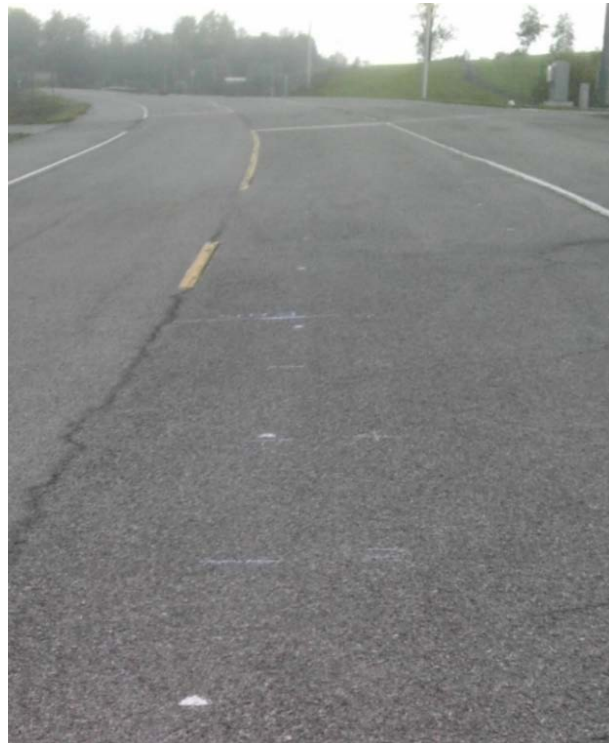

Research approach

- Equipment: CTMeter, HSLD

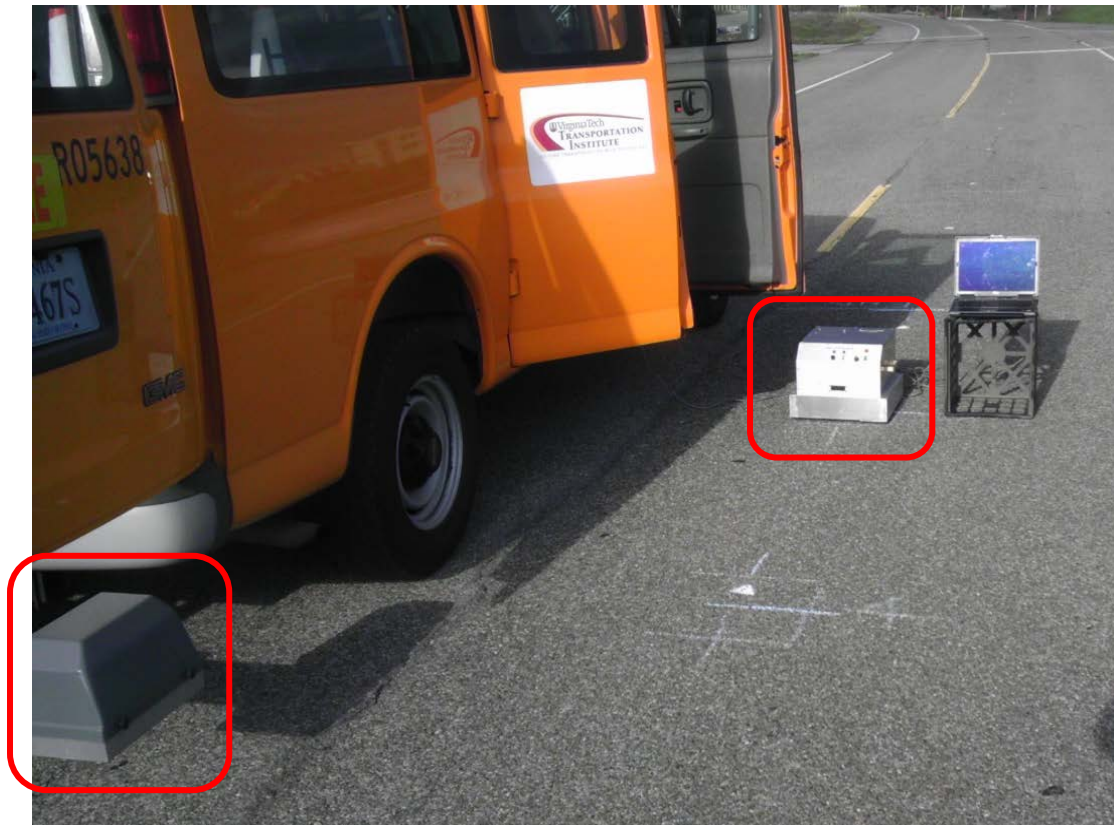

Research approach

- Measurements setup:

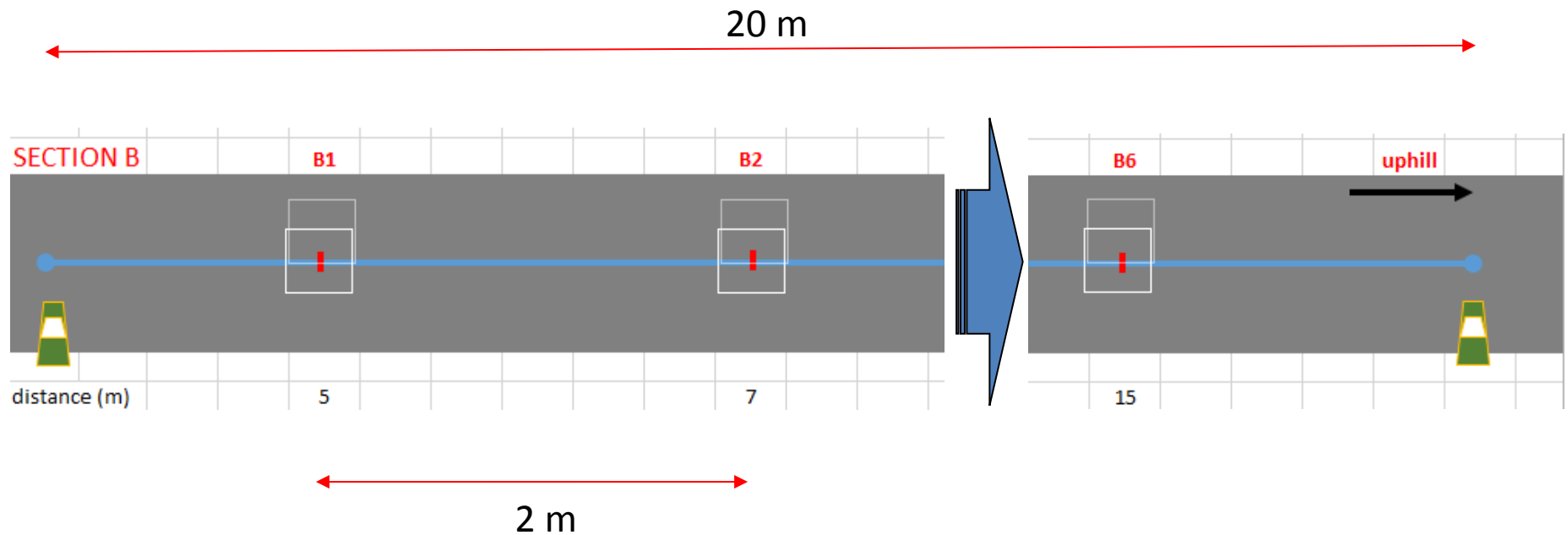

Research approach

- Static Measurements (CTmeter)

6 measurements wheel path, 6 measurements offset, for each location (B1 – B6), i.e. below: B6

	wheel path							
[1]	A: 1.60(1%)[1.10]	B: 1.12(1%)[0.88]	C: 1.53(0%)[1.97]	D: 1.41(0%)[1.01]	E: 1.01(0%)[0.87]	F: 1.47(3%)[0.90]	G: 1.66(4%)[0.95]	H: 1.41(2%)[0.80]
[2]	A: 1.63(0%)[1.07]	B: 1.13(2%)[0.89]	C: 1.32(0%)[0.70]	D: 1.46(0%)[1.02]	E: 1.01(2%)[0.86]	F: 1.44(5%)[0.89]	G: 1.69(3%)[0.95]	H: 1.47(2%)[0.81]
[3]	A: 1.61(1%)[1.08]	B: 1.17(2%)[0.88]	C: 1.38(0%)[1.00]	D: 1.50(0%)[1.02]	E: 1.02(4%)[0.86]	F: 1.42(4%)[0.86]	G: 1.70(2%)[0.96]	H: 1.40(2%)[0.80]
[4]	A: 1.63(2%)[1.10]	B: 1.15(2%)[0.86]	C: 1.30(0%)[0.71]	D: 1.45(0%)[1.01]	E: 0.99(0%)[0.86]	F: 1.42(4%)[0.87]	G: 1.65(2%)[0.95]	H: 1.45(2%)[0.80]
[5]	A: 1.66(0%)[1.09]	B: 1.14(2%)[0.84]	C: 1.26(0%)[0.69]	D: 1.46(0%)[1.02]	E: 1.05(3%)[0.88]	F: 1.45(3%)[0.86]	G: 1.62(2%)[0.93]	H: 1.22(2%)[0.79]
[6]	A: 1.63(1%)[1.07]	B: 1.10(2%)[0.85]	C: 1.28(0%)[0.70]	D: 1.47(0%)[1.02]	E: 1.01(0%)[0.87]	F: 1.45(4%)[0.89]	G: 1.68(3%)[0.95]	H: 1.22(1%)[0.80]
	offset							
[1]	A: 1.47(0%)[1.02]	B: 1.59(2%)[1.14]	C: 1.52(1%)[1.89]	D: 2.05(0%)[1.47]	E: 1.22(2%)[0.91]	F: 0.88(1%)[1.21]	G: 1.84(0%)[1.36]	H: 1.51(0%)[1.52]
[2]	A: 1.44(0%)[1.01]	B: 1.60(2%)[1.12]	C: 1.55(1%)[1.88]	D: 2.07(0%)[1.47]	E: 1.26(2%)[0.92]	F: 0.91(0%)[1.21]	G: 1.83(1%)[1.36]	H: 1.51(0%)[1.51]
[3]	A: 1.47(0%)[1.02]	B: 1.60(1%)[1.13]	C: 1.57(1%)[1.88]	D: 2.04(0%)[1.47]	E: 1.27(2%)[0.90]	F: 0.89(0%)[1.20]	G: 1.74(2%)[1.33]	H: 1.49(0%)[1.51]
[4]	A: 1.46(1%)[1.02]	B: 1.58(1%)[1.16]	C: 1.48(1%)[1.88]	D: 2.07(0%)[1.48]	E: 1.29(5%)[0.91]	F: 0.86(1%)[1.18]	G: 1.85(0%)[1.36]	H: 1.48(0%)[1.50]
[5]	A: 1.49(0%)[1.02]	B: 1.59(1%)[1.11]	C: 1.52(1%)[1.87]	D: 2.01(0%)[1.47]	E: 1.22(2%)[0.89]	F: 0.90(0%)[1.21]	G: 1.74(2%)[1.32]	H: 1.53(0%)[1.52]
[6]	A: 1.44(1%)[1.03]	B: 1.56(2%)[1.11]	C: 1.47(1%)[1.86]	D: 2.04(0%)[1.45]	E: 1.27(3%)[0.90]	F: 0.97(0%)[1.21]	G: 1.80(1%)[1.34]	H: 1.53(0%)[1.52]

576 calculated MPD measurements (100 mm)

Research approach

- **Measurements**

5 measurements wheel path 50 mph along 20 m., i.e. below: run 1 at 50 mph



1,000 calculated MPD Measurements (100 mm)

Research approach

- Spikes' identification
 - Discrete Wavelet transform
 - Transform the signal into another representation which presents the signal information in a more useful form
 - DWT "decompose" the signal, using discrete values of the dilation and translation
 - Discrete Wavelet Transform type Haar, allows to look for 'differences' between adjacent data points at different levels

Research approach

- Spikes' identification

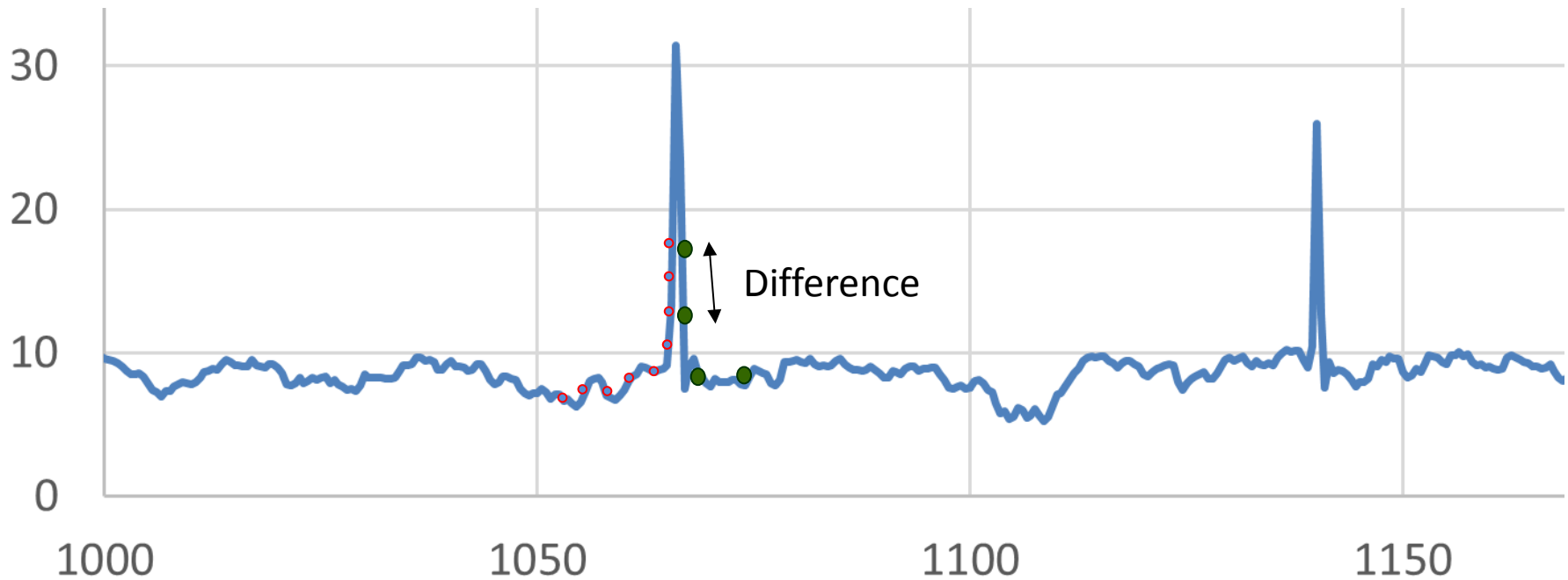

Research approach

- Spikes removal
 - Histogram for the differences (finest scale)

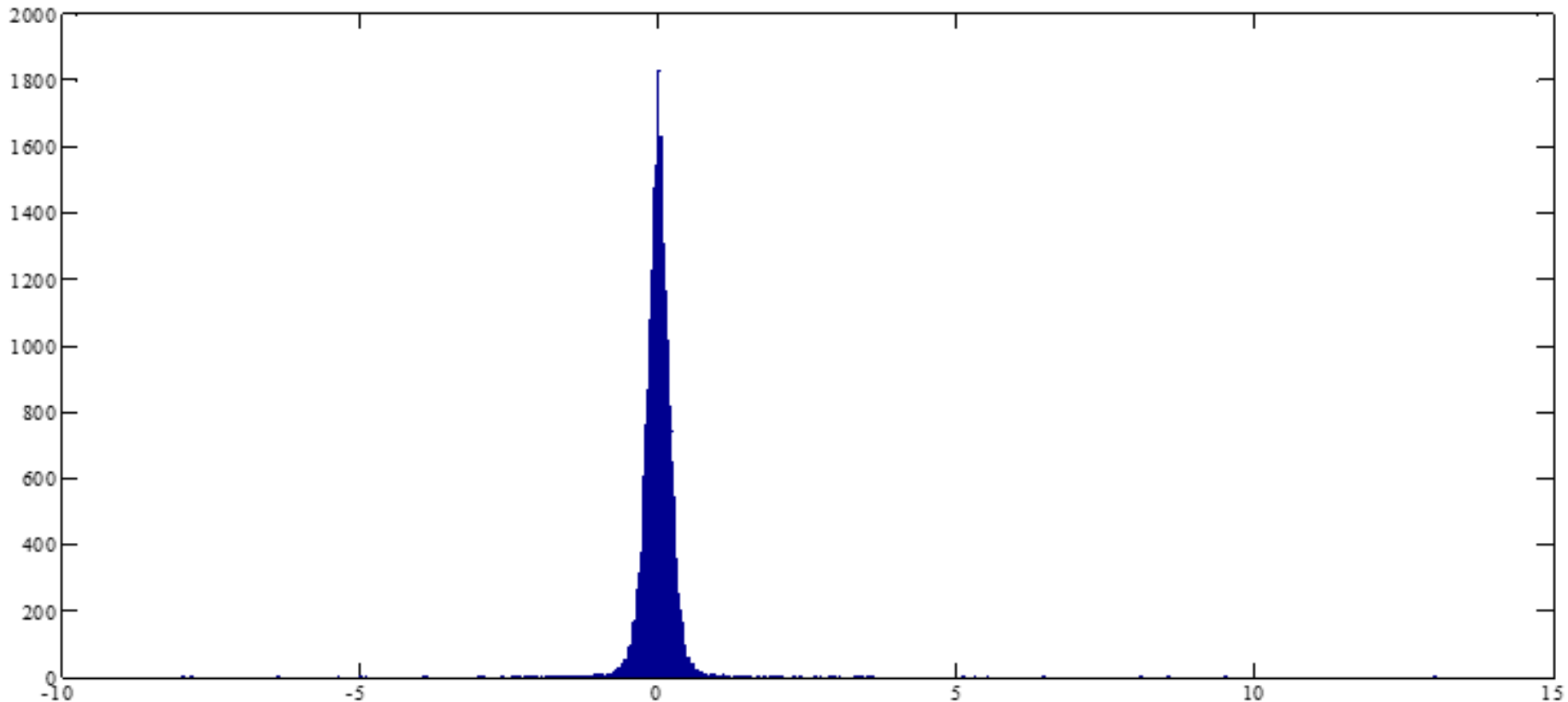

Research approach

- Spikes removal
 - Histogram for the differences

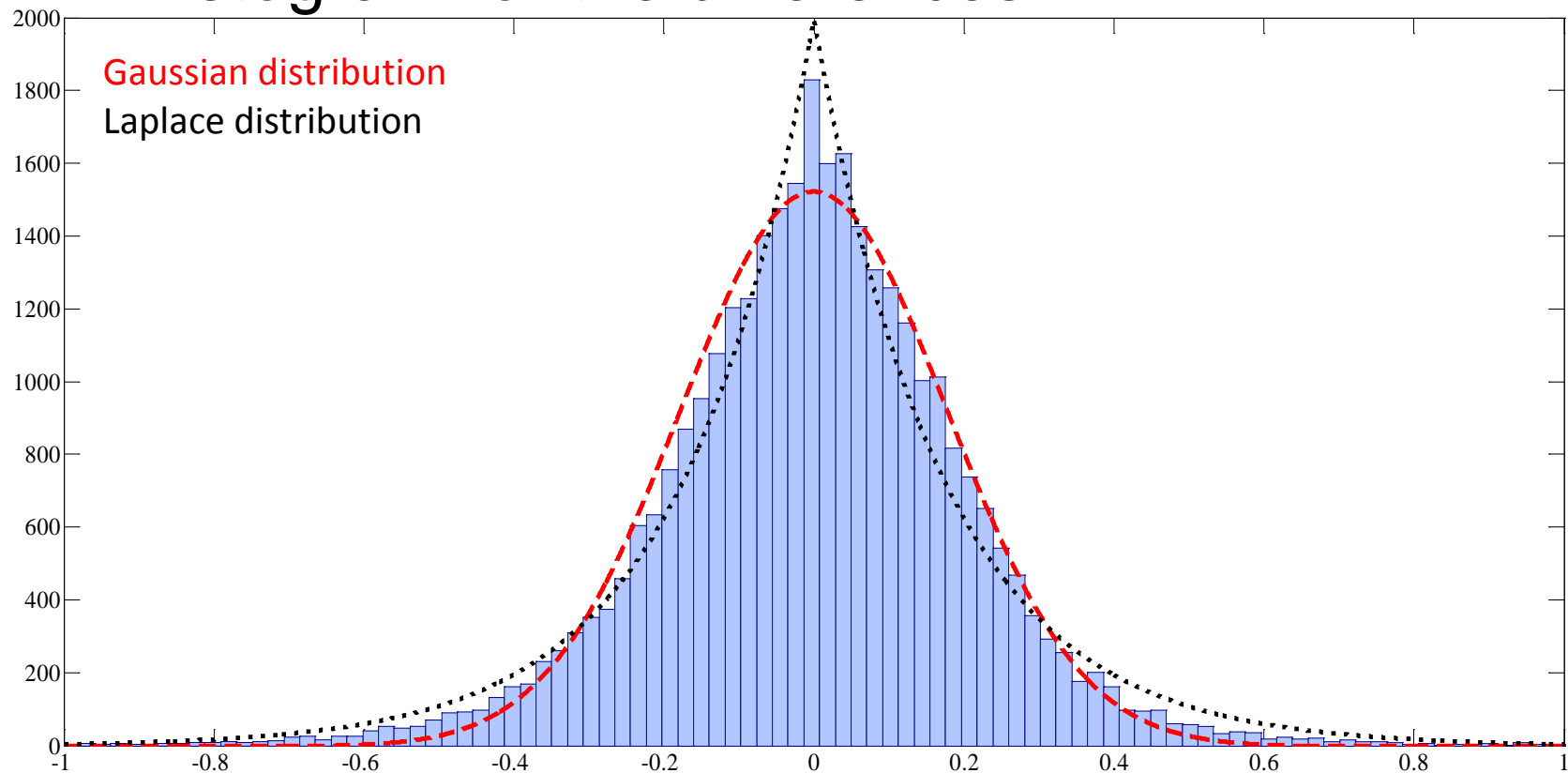

Research approach

- Spikes removal
 - Histogram for the differences

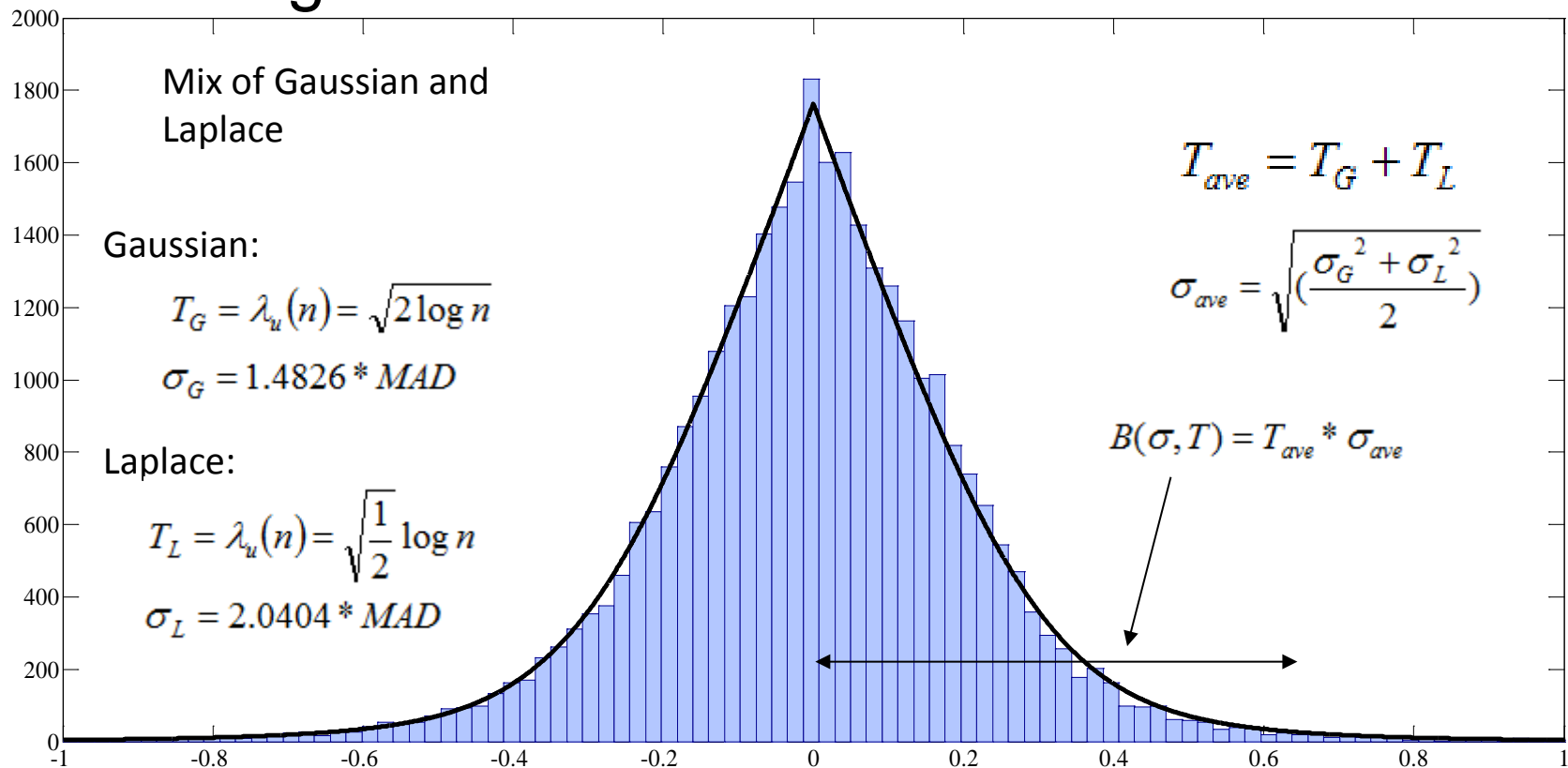

Research approach

- After spikes removal and re-composition of the original data (now without spikes):
- MPD calculation
 - According to the ASTM E1845-09
 - A moving average 2.5 mm low-pass filter was applied before the finding of the MPD
 - The relative slope was also removed before

Results

- Spikes removal

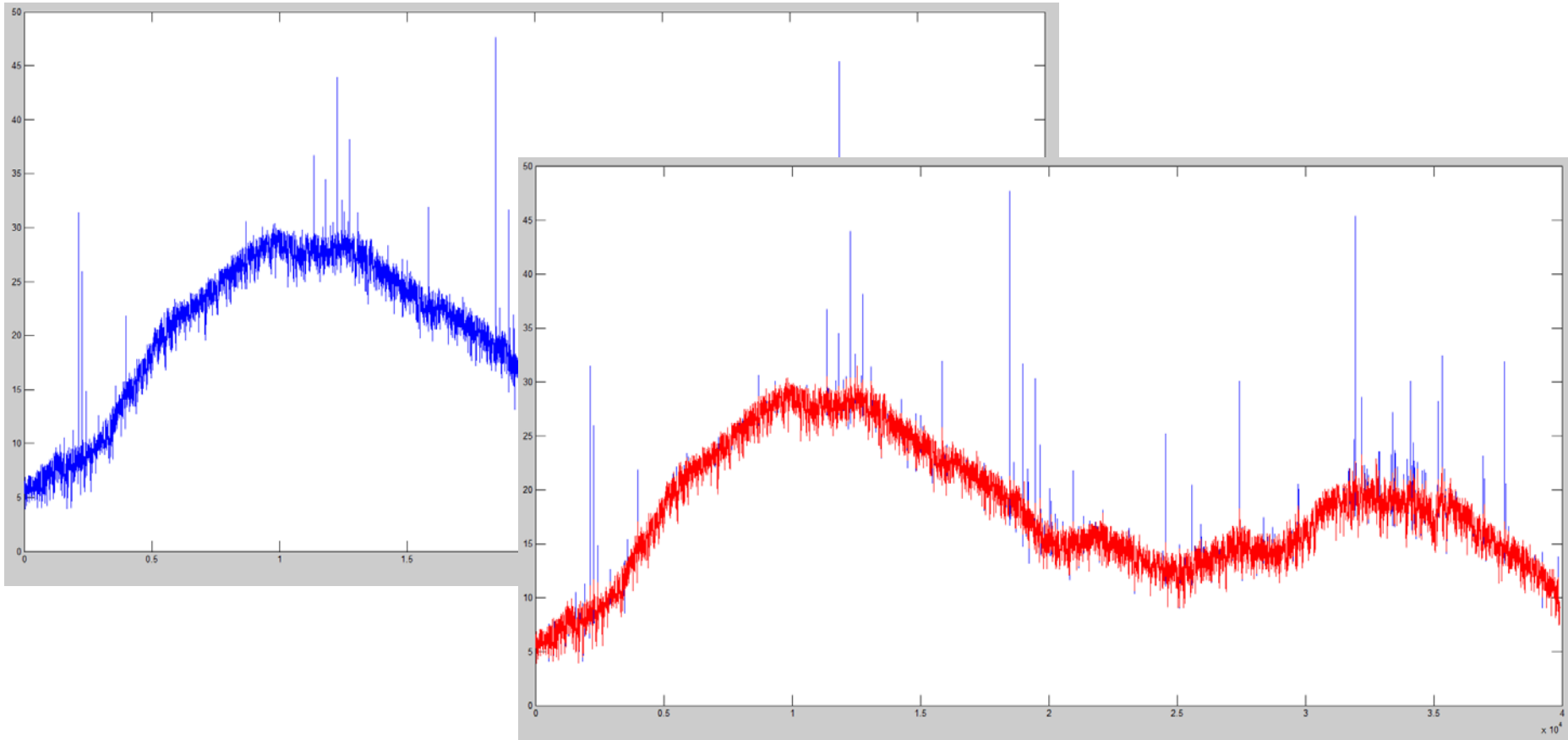

Results

- Spikes removal

- Data points every 0.5 mm (100mm of data)

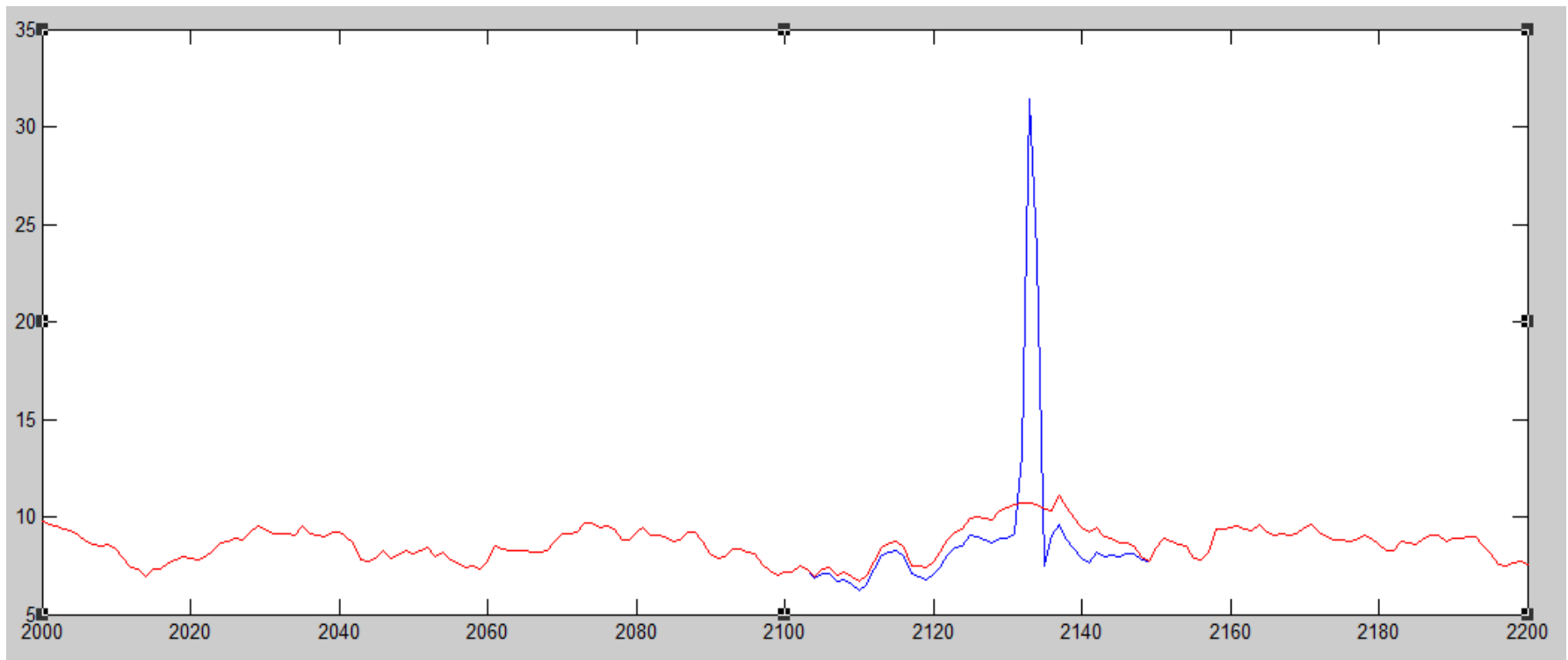

Results

- N-way ANOVA test → to see the influence of all variables involved on the CTmeter measurements:

- the influence of the measurements for different sectors



- the influence of moving the equipment longitudinally, and

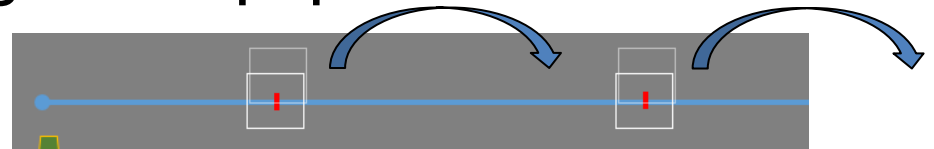

- the influence of moving the equipment transversally along the wheel path.

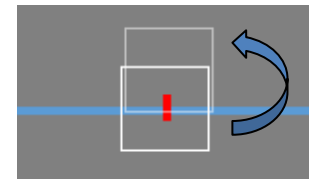

Results

Analysis of Variance					
Source	Sum Sq.	d.f.	Mean Sq.	F	Prob>F
X1	0.03974	1	0.03974	0.46	0.5016
X2	0.4261	5	0.08522	0.98	0.437
X3	0.74054	7	0.10579	1.21	0.3053
Error	7.15424	82	0.08725		
Total	8.36063	95			

- all p-values for the three analyzed variables are far from being small (p-values \rightarrow 0 are significant),
- Indicating that none of the variables are significant in the results for a 95% confidence,
- \rightarrow the analysis was made considering all the 576 values as individual MPD values for the validation

Results

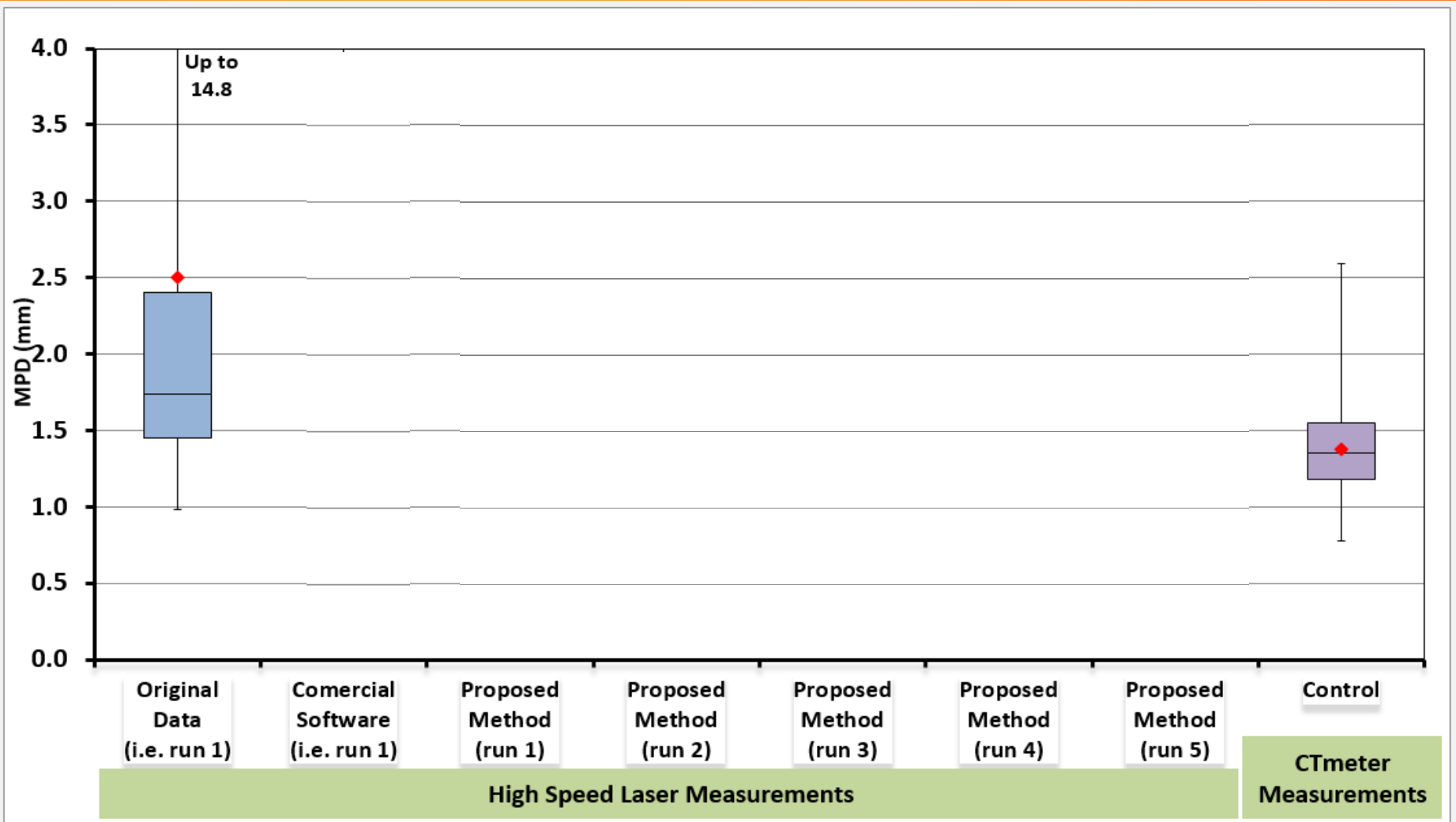

Conclusions

- The CTmeter sectors, spatial location (longitudinally, transversally) did not have an effect on the MPD.
→ This allowed us to confidently compare measurement from the high speed device and the CTmeter without having to worry about exactly matching the location of measurements.
- Spikes in the measurements collected with the HSLD resulted in MPD values that were about 50% higher than those provided by the CTmeter. Removing the spikes with the proposed method resulted in mean MPD calculated from the high-speed device that were essentially the same as the one calculated from the CTmeter.

Thank you
for your
attention