

Wavy Characteristics and Its Evaluation Index Determining Ride Quality of Rut Profile

Pavement Evaluation Conference 2010

Oct 26, 2010

Roanoke, VA



KITAMI INSTITUTE OF TECHNOLOGY

Kazuya TOMIYAMA (Kitami Institute of Technology)
Akira KAWAMURA (Kitami Institute of Technology)
Tateki ISHIDA (Civil Engineering Research Institute)
Masakazu JYOMOTO (Kitami Institute of Technology)



Contents



1. Background & Motivation

2. Mathematical Derivations of the HRD

3. Driving Simulator Experiment

4. Wavy Characteristics of Rut Profile

5. Index Development

6. Conclusions



1. Background & Motivation

In recent years, road user's demand for the maintenance and improvement of pavement surfaces has diversified and has extended to not only the traditional states but also the ride quality point of view.

KIT

1. Background & Motivation

❖ Pavement Rutting is...



affecting comfort & safety
of a vehicle

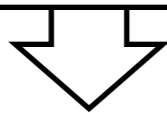

special concern to road users
as well as road administrators

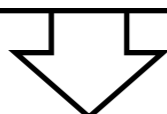

primary index for
pavement management

currently evaluated by Rut depth

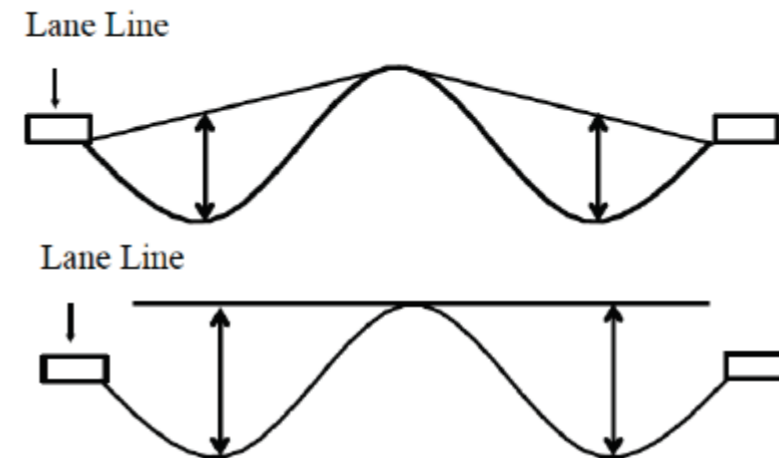

Some Definitions of Rut Depth Measurement

Evaluation Point of view

(a) User's Safety

- vehicle handling characteristics
- hydroplaning, drainage

(b) Pavement Structure & Material

Problems of Rut Depth

There is no reference to what characteristics of rutting contribute to users in terms of ride quality.

1. Background & Motivation

❖ Rutting Evaluation based on the Vehicle Dynamics

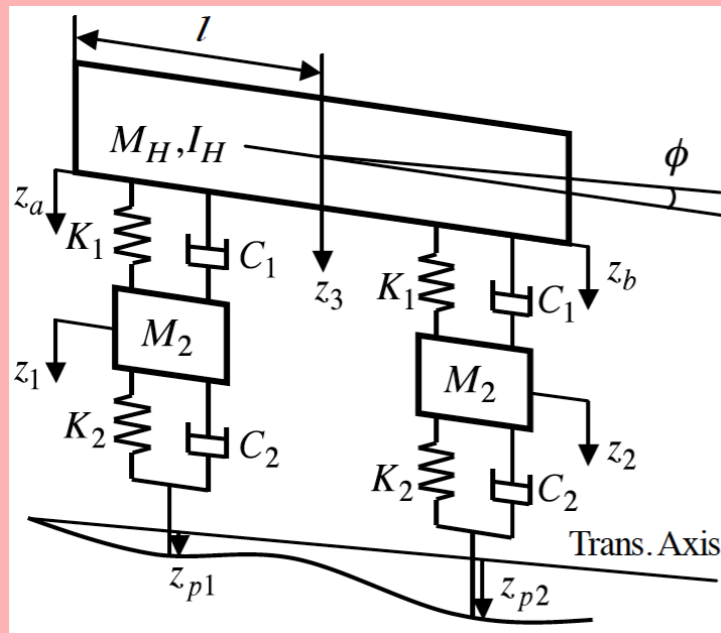

Half-Car based Index for
Rutting Distress (HRD)

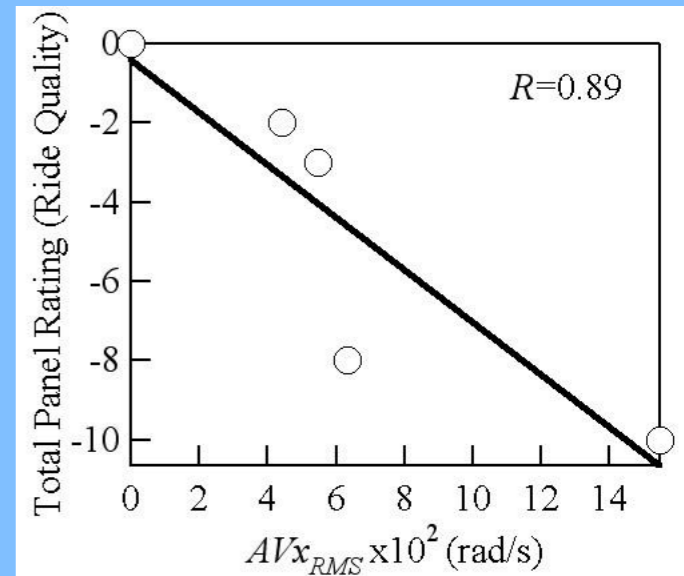

Subjective Ride Quality Rating by a Driving Simulator
Ride Quality in a Lane-Change Maneuver

➔ Correlation between the HRD and Subjective Rating

❖ Objective of This Study

- identifies wavy characteristics of rut profiles corresponding to the ride quality
- develops a new evaluation index of rutting according to the wavy characteristics

2. Mathematical Derivations of the HRD

In a HRD analysis, the HC model simulates the rolling motion of the center of mass point for the body caused by a lane-change maneuver in rutting. This section describes mathematical derivations of the HRD.

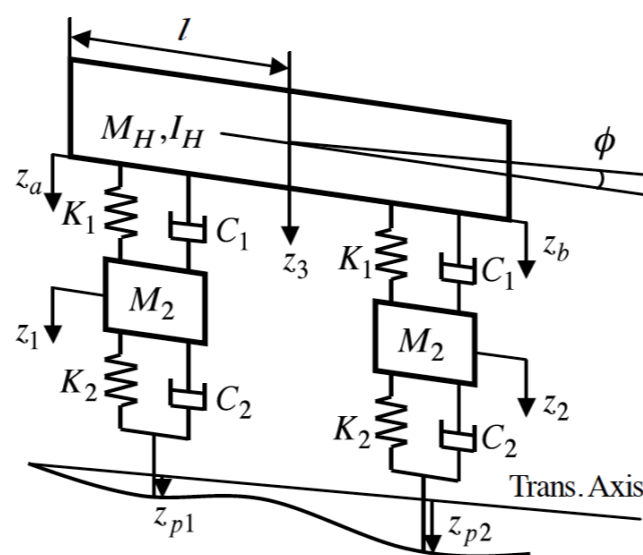

2. Mathematical Derivations of the HRD

❖ Half-Car Simulation Model

The HRD uses the HC model specified in the ASTM standard

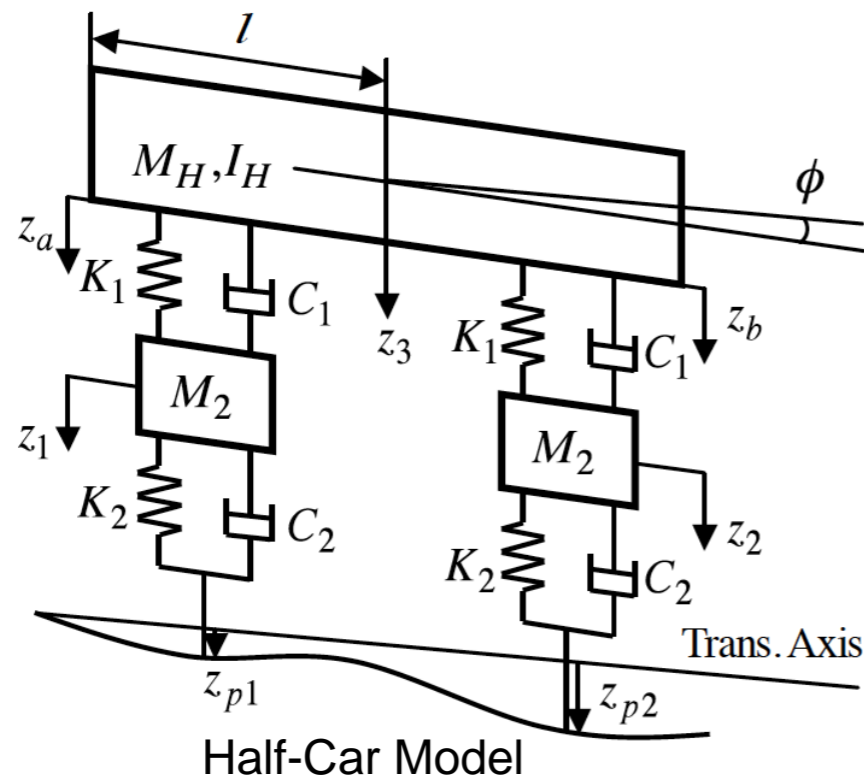

C_1 : damper value (kgs/m)

I_H : roll moment of inertia (kgs²m)

K_1 : vehicle spring constant (kg/m)

K_2 : tire stiffness (kg/m)

l : one half of tread width (m)

M_H : body mass (kgs²/m)

M_2 : unsprung mass (kgs²/m)

z_a, z_b : sprung mass displacement (mm)

z_1, z_2 : unsprung mass displacement (mm)

z_3 : center of gravity displacement of body (mm)

z_{p1}, z_{p2} : transverse profile elevation (mm)

ϕ : roll rotation of body (rad)

$$M_2 \ddot{z}_1 = K_2(z_{p1} - z_1) - C_1(\dot{z}_1 - \dot{z}_a) - K_1(z_1 - z_a)$$

$$M_2 \ddot{z}_2 = K_2(z_{p2} - z_2) - C_1(\dot{z}_2 - \dot{z}_b) - K_1(z_2 - z_b)$$

$$M_H \ddot{z}_3 = C_1(\dot{z}_1 - \dot{z}_a) + K_1(z_1 - z_a) \\ + C_1(\dot{z}_2 - \dot{z}_b) + K_1(z_2 - z_b)$$

$$I_H \ddot{\phi} = \{C_1(\dot{z}_1 - \dot{z}_a) + K_1(z_1 - z_a)\}l \\ - \{C_1(\dot{z}_2 - \dot{z}_b) + K_1(z_2 - z_b)\}l$$

Parameter: Roll Rate

2. Mathematical Derivations of the HRD

❖ Simulation Procedures

The transition Speed $v(t)$ and the adjusted tread width L enables the simulation of a lane-change maneuver for a single profile

$$v(t) = V(t) * W_1 / \sqrt{W_1^2 + W_2^2}$$

$$L = l * W_1 / \sqrt{W_1^2 + W_2^2}$$

where,

$V(t)$: vehicle forward speed (80km/h),

W_1 : transition width (3.5m),

W_2 : transition distance (30m)

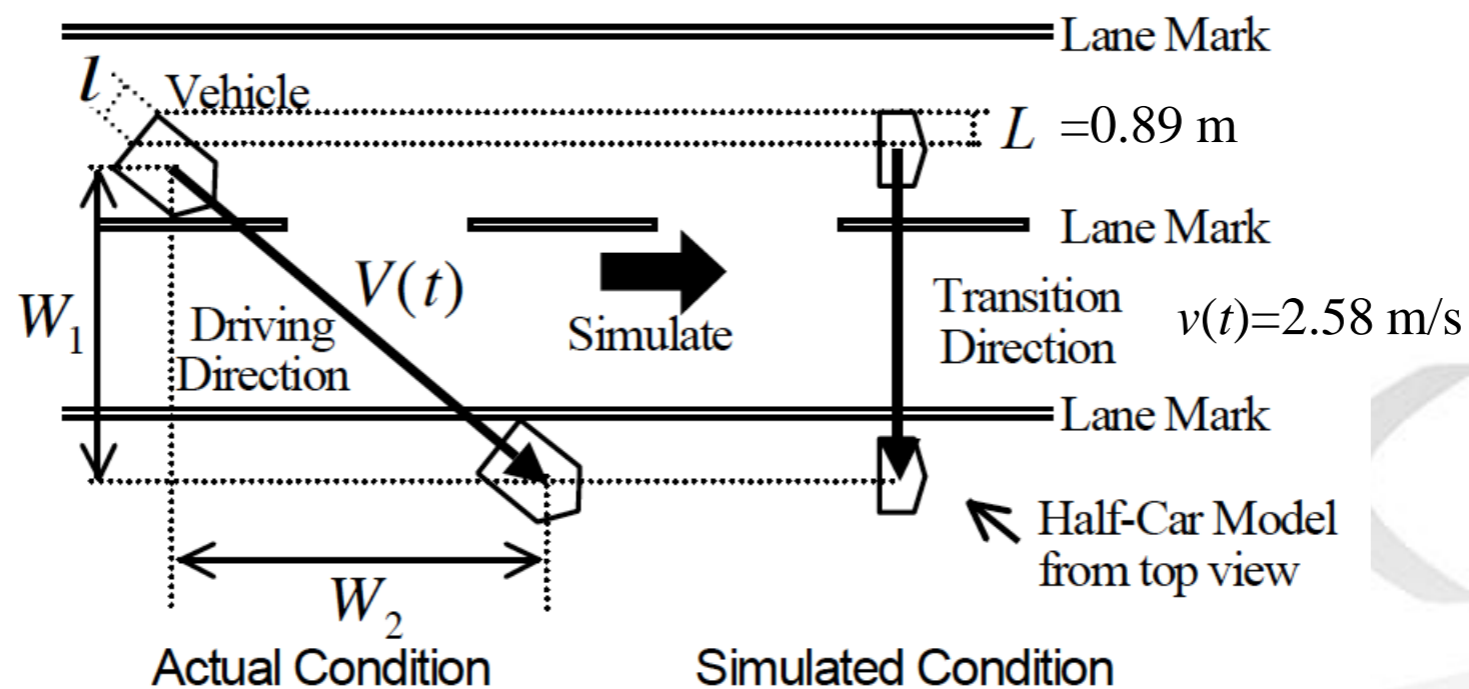

Schematic Explanation of the Transition Speed

2. Mathematical Derivations of the HRD

❖ Set of the Vehicle Parameters

The HC simulation uses a set of specific vehicle parameters normalized by the sprung mass to simplify the equations

$$K_1/M_H = 32 (s^{-2}); \quad K_2/M_H = 326 (s^{-2}); \quad M_2/M_H = 0.075 (-); \quad C_1/M_H = 3 (s^{-2});$$

$$I_H/(M_H b^2) = 0.42 (-); \quad b = 2 * l = 1.8 (m)$$

❖ Definition of HRD (Half-Car based Index for Rutting Distress)

The HRD is the Root-Mean-Square (RMS) averaged roll rate value of the sprung mass obtained by the HC simulation.

$$HRD = \sqrt{\frac{1}{N} \sum_{i=1}^N AVx_i^2}$$

where,

HRD: Half-Car based Index for Rutting Distress (rad/s)

AVx: Roll Rate of the Sprung mass (rad/s)

N: Number of Data



3. Driving Simulator Experiment

This section examines the correlation between the HRD values and subjective ride quality ratings when traveling on the rutted road



3. Driving Simulator Experiment

❖ KITDS (Kitami Institute of Technology Driving Simulator)

Conventional Simulator

- Safety of subjects
- Easy setting of test conditions
- Repeatability of test conditions
- Economical testing

KITDS

- Road surface evaluation
 - / Roughness
 - / Rutting
 - / Skid resistance

+



Overview of the KITDS

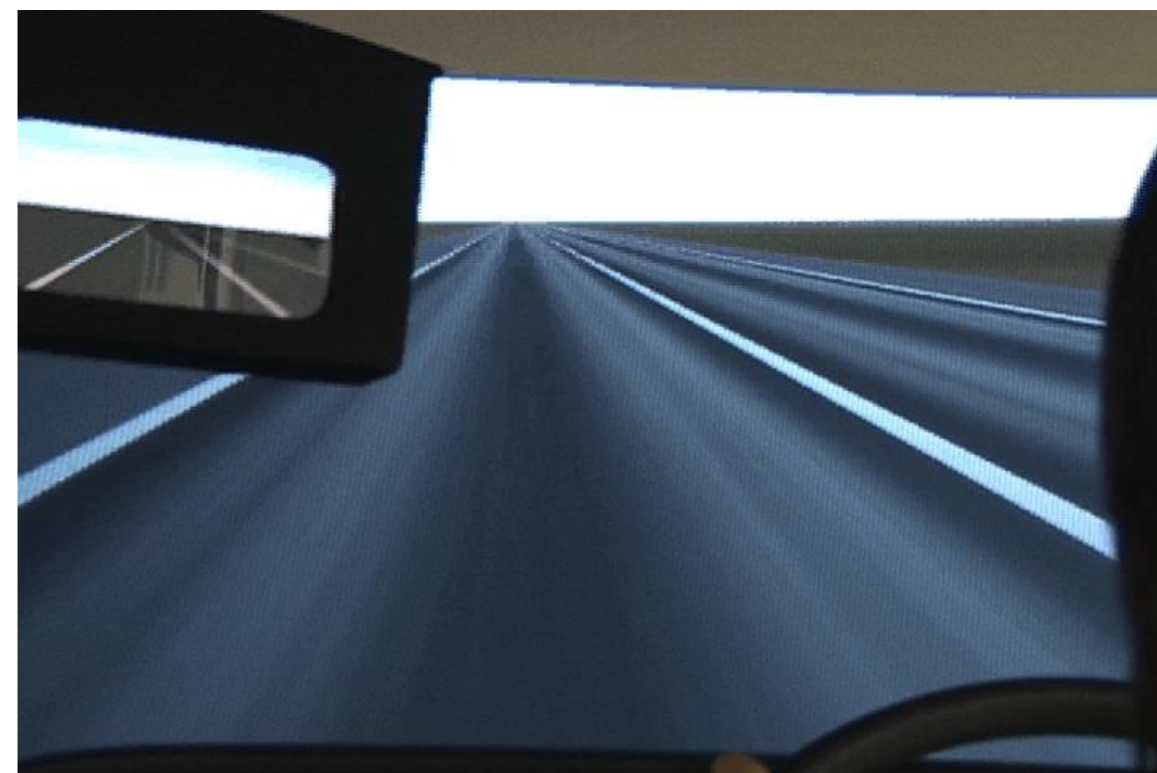

Virtual proving ground



3. Driving Simulator Experiment

❖ Experimental Scenario

Four rutted profiles were obtained from the PIARC EVEN data, and a perfect smooth profile was prepared

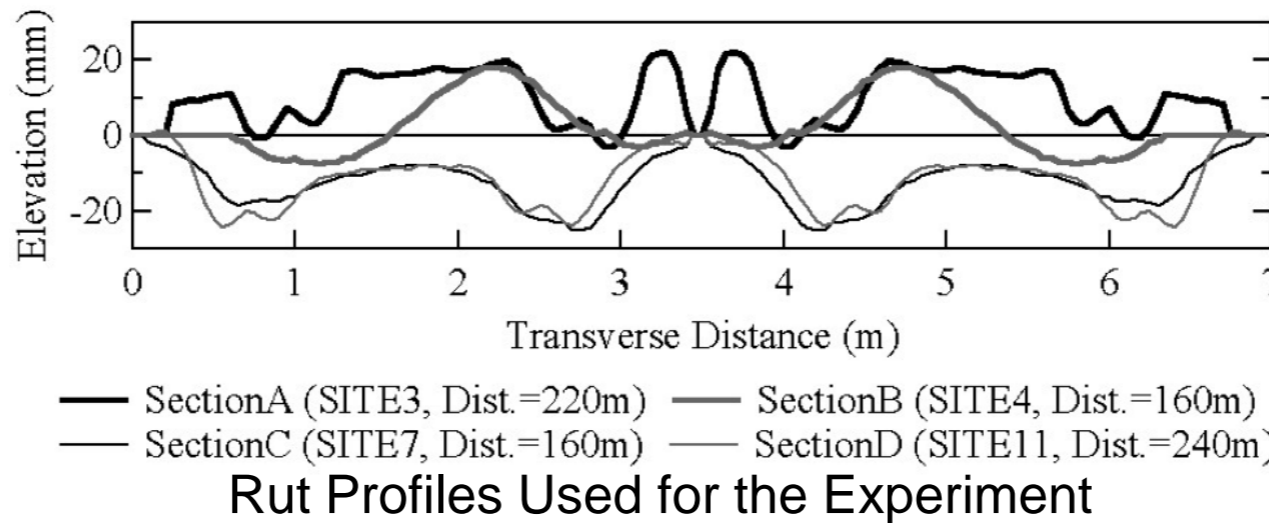

8 drivers performed double lane-change maneuver defined by the ISO, keeping a constant driving speed of 60km/h.

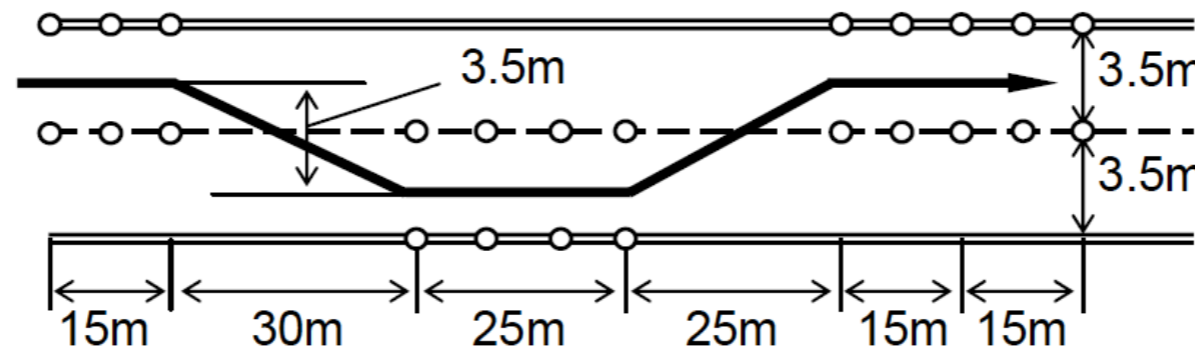

Track Layout of Double Lane-Change Test
Ex. ISO3888-1



3. Driving Simulator Experiment



❖ Experimental Results

The Drivers were asked to answer the questionnaire about the ride quality

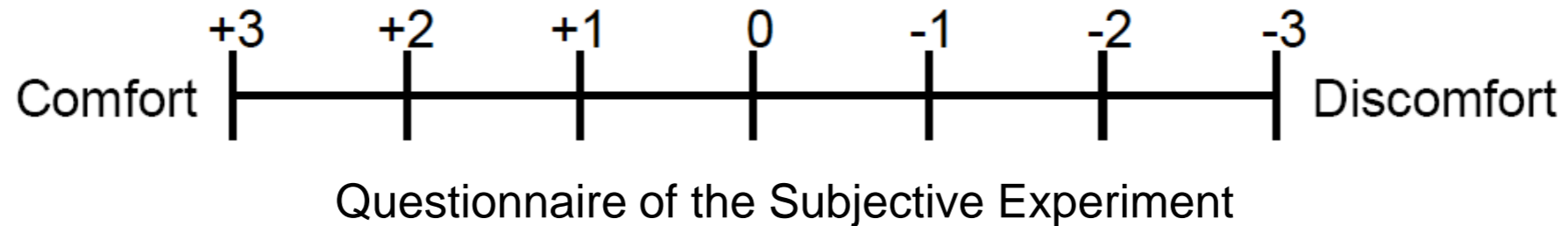

The HRD highly correlates with subjective total panel ratings ($R=0.89$, $p<0.05$)

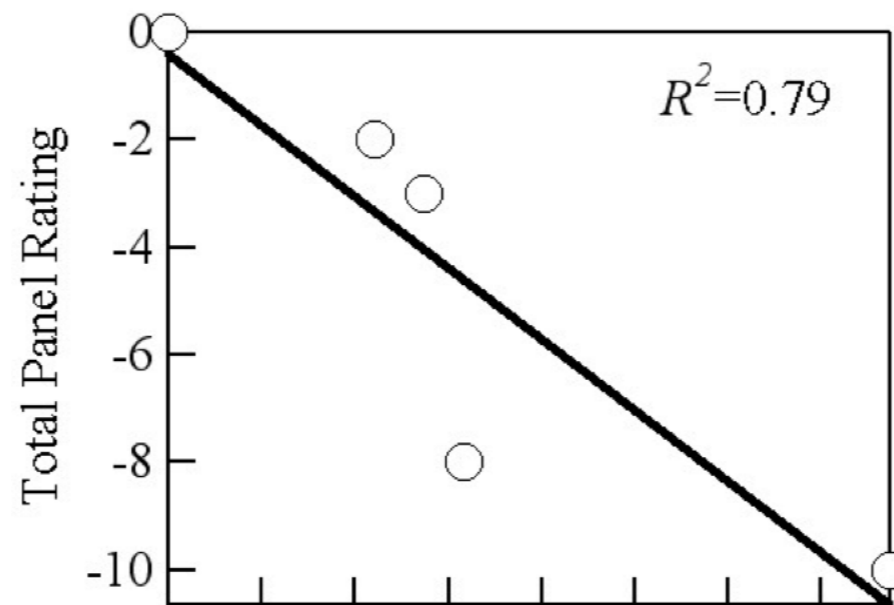

The HRD enables us to evaluate the severity levels of rutting in terms of the ride quality

4. Wavy Characteristics of Rut Profile

This section examines the wavy characteristics of rut profiles in terms of the ride quality scaled by the HRD.

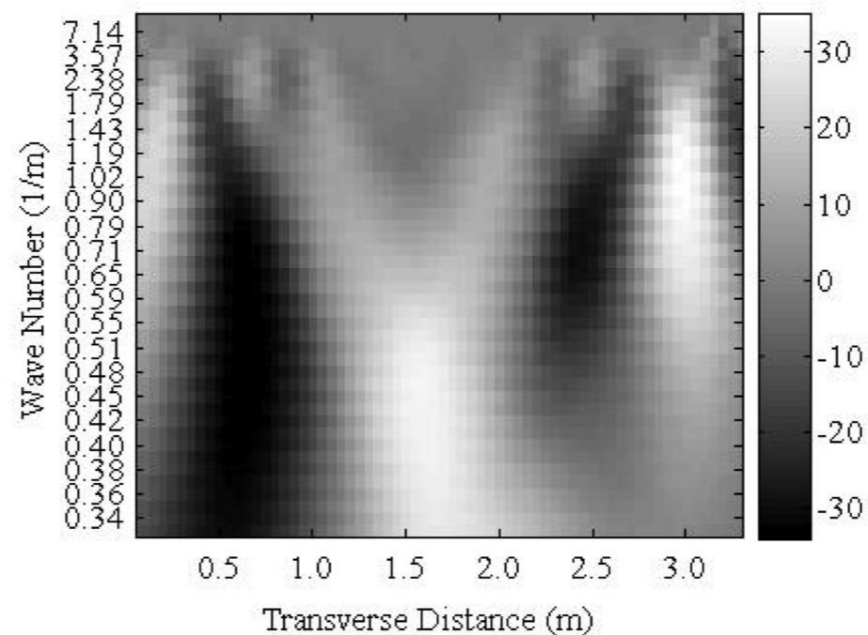



4. Wavy Characteristics of Rut Profile

❖ What is the Wavy Characteristics of a Road Profile

Wavy characteristics of a road profile indicate that the basic characteristics and its derived characteristics are represented by certain wavelength ranges of the profile

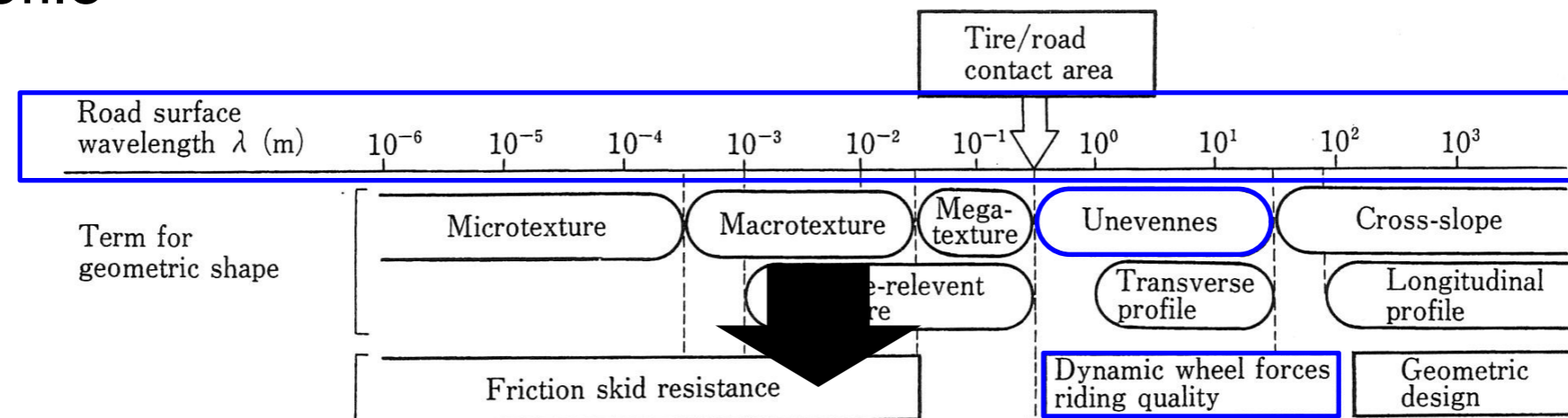

Approach:
Waveband analysis of a road profile by the continuous wavelet transform (CWT)

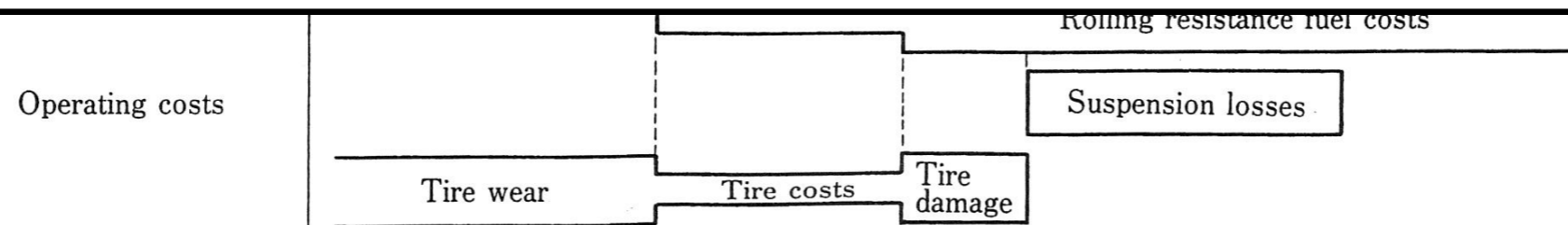

How about wavy characteristics for transverse profiles?

4. Wavy Characteristics of Rut Profile

❖ Analyzed Transverse Profile Data

- 147 profiles obtained from PIARC EVEN Project were selected
- The profiles were measured by the Dipstick[®] and the rod-and-level
- The sampling interval of the profiles was set to 0.05m

Features of the Transverse Profile Data

Test Section	Number of Cross-Sections	Lane Width (m)	Features of the Transverse Profile		
			Range of Rut Depth (mm)	Wearing / Flowing	Dual / Single
No. 2	21	3.20	9 - 12	Wearing	Single
No. 3		3.25	21 - 37	Flowing	Dual
No. 4		3.00	17 - 33	Flowing	Single
No. 7		3.45	21 - 28	Wearing	Dual
No. 8		3.15	9 - 13	Wearing, Flowing	Dual
No. 11		3.45	24 - 32	Wearing	Dual
No. 12		3.55	14 - 18	Flowing	Dual

❖ Features of Pavement Rutting

- Rut Depth
- Wearing or Flowing
- Dual or Single

4. Wavy Characteristics of Rut Profile

❖ Features of Pavement Rutting

- **Rut depth**, it is defined by the elevation difference between the highest and the lowest points of a profile
- **Wearing or Flowing**, it is one of the important features of rutting and is defined by the positive or negative condition of the lane center, respectively
- **Dual or Single**, it is also one of the significant conditions of rutting and is caused by heavy trucks with dual wheels or by the other vehicles with single wheels, respectively

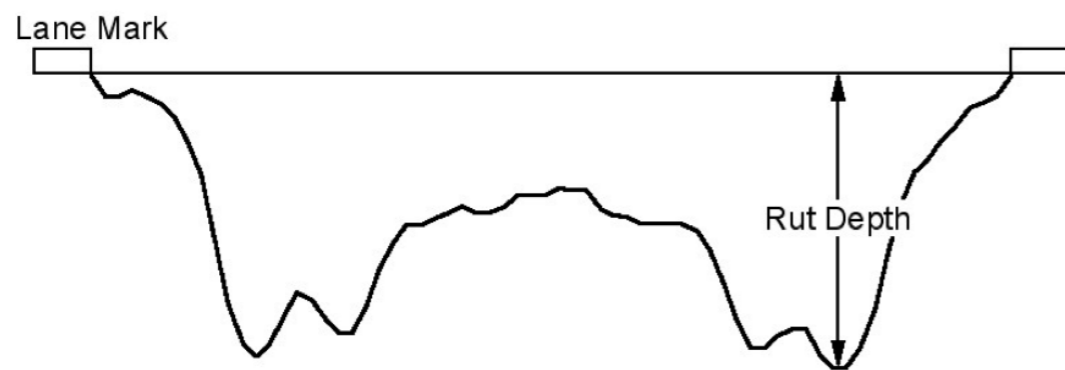

Wearing with Dual-Wheel Ruts



Flowing with Single-Wheel Ruts

Schematic of Features of Rutting and Rut Depth Measurement

4. Wavy Characteristics of Rut Profile

❖ Continuous Wavelet Transform (CWT)

The CWT of a signal $f(t)$ at a distance u and a scale s is defined as the following equation: (* indicates complex conjugate)

$$Wf(u,s) = \int_{-\infty}^{\infty} f(t) \frac{1}{\sqrt{s}} \psi^* \left(\frac{t-u}{s} \right) dt$$

Since rut profiles are nearly symmetrical about the lane center, **4th order Symlet** has been used as the mother wavelet $\psi(t)$

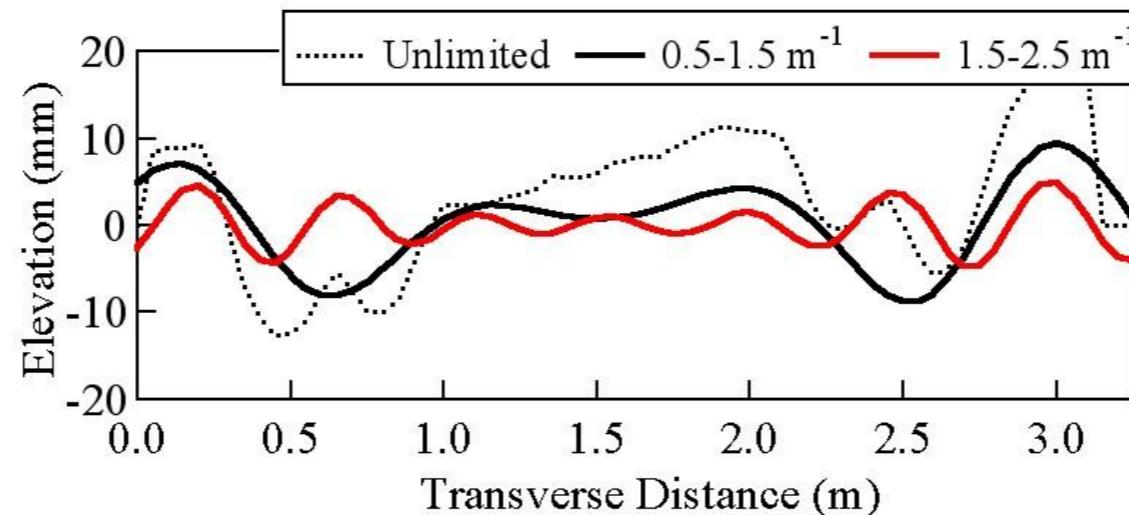

An example of a waveband-limited rut profile

The rut profile is nearly symmetrical about the lane center and/or any peaks when it is decomposed to some wavebands by a filter

4. Wavy Characteristics of Rut Profile

❖ Continuous Wavelet Transform (CWT)

The relationship between the scale and the wave number of a signal is described as

$$F_s = \frac{F_c}{s \cdot \Delta}$$

where,

F_s : the pseudo-wave number corresponding to the scale s , in m^{-1}

F_c : the center spatial frequency of a mother wavelet in m^{-1}

Δ : the sampling period (s)

❖ Result of the CWT

Gray scale: wavelet coefficients associated with the magnitude of the profile fluctuations

Wave Number $1.79m^{-1}$

Trans. Dist. 0.7m & 2.5m: Dual Ruts

Wave Number $< 0.60m^{-1}$

Trans. Dist. 1.2~2.0m: Flowing (Bulge)

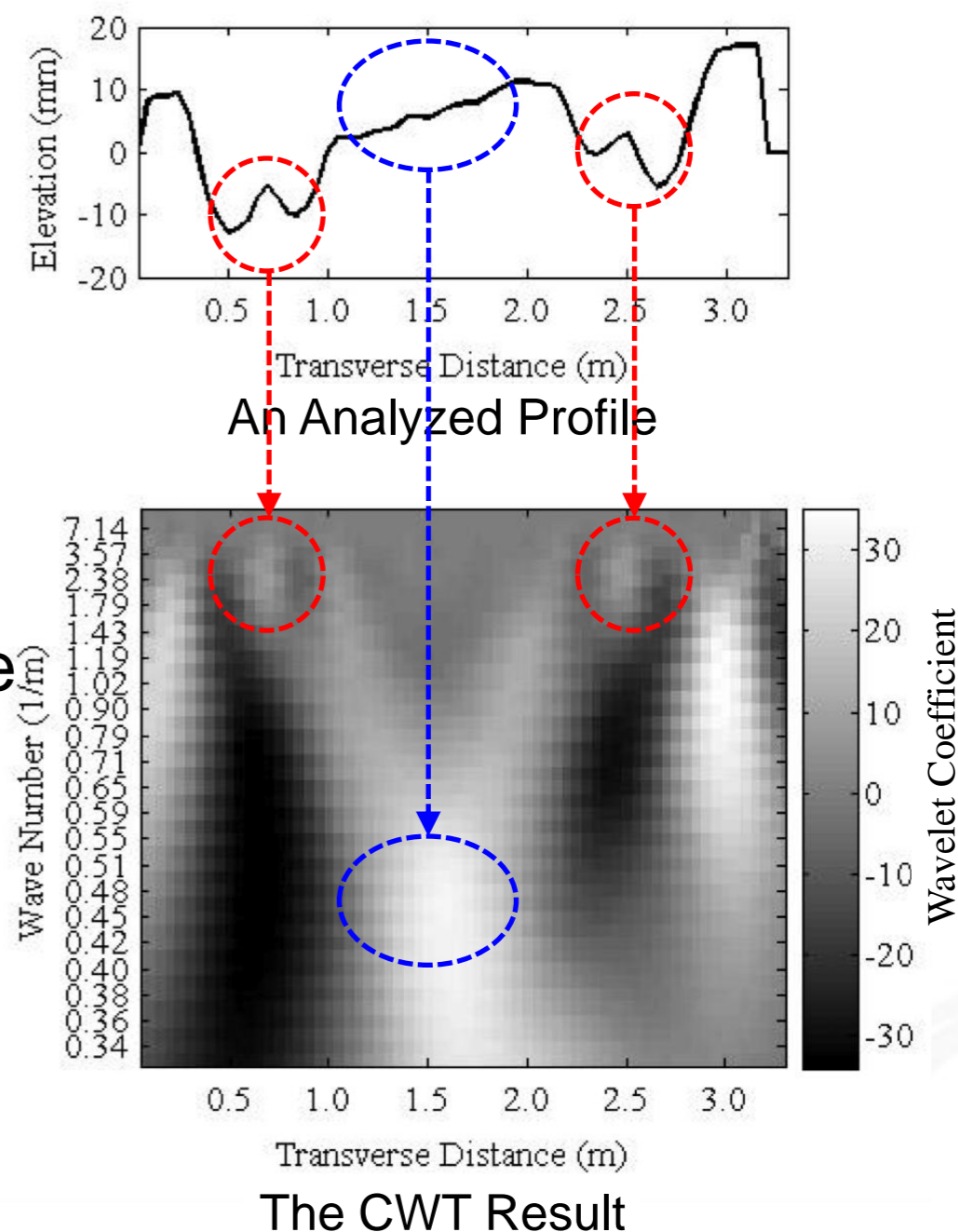

4. Wavy Characteristics of Rut Profile

❖ Waveband Analysis

The correlations between the RMS wavelet coefficients for each wave number and the associated HRD values are considered

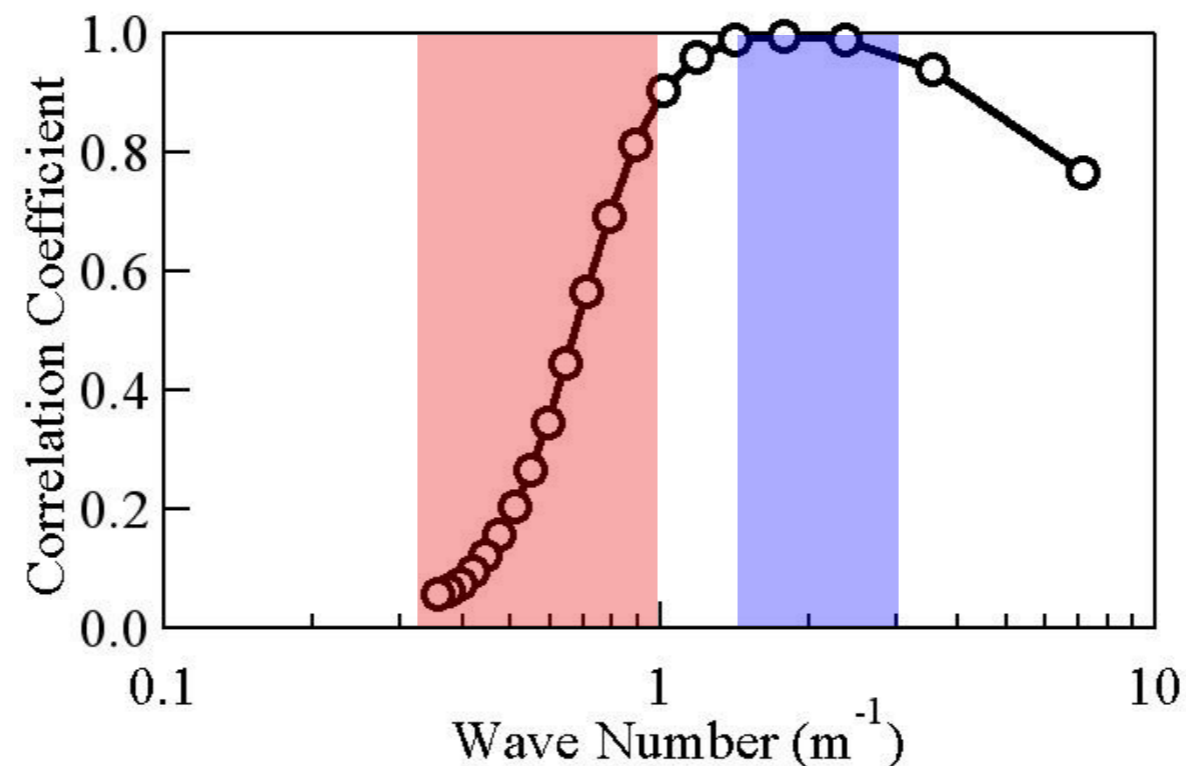

Correlations between RMS Wavelet Coefficients and HRD values

Wave Numbers $1.5-3.0m^{-1}$
(Wavelengths $0.33-0.67m$):
High Correlation ($R>0.8$)

Wave Numbers $< 1m^{-1}$
(Wavelengths $>1.0m$):
Correlation is rapidly dropping

4. Wavy Characteristics of Rut Profile



❖ Waveband Analysis

The maximum roll rate response of the HC model in the range $1.5-3.0\text{m}^{-1}$:
Wave Number 2.5m^{-1} (wavelength of 0.4m)

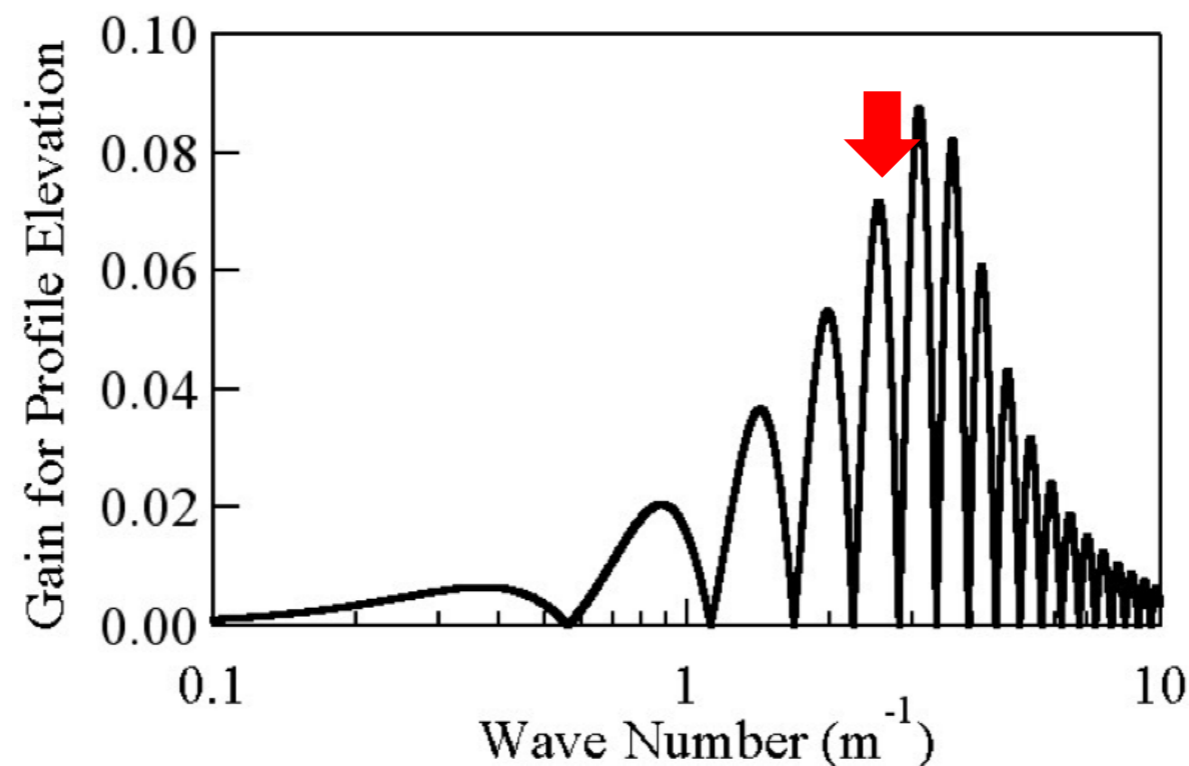

Roll Rate Response Gain of the Half-Car Model to Profile Fluctuations

The Wavy Characteristics of Rut Profiles

Wavelengths $0.33-0.67\text{m}$ affect the vehicle motion

Wavelength 0.4m : seriously reduces the riding comfort

5. Index Development

This section deals with a method for detecting profile fluctuations associated with the particular wavy characteristics corresponding to the ride quality and develops an index taking the wavy characteristics into consideration.

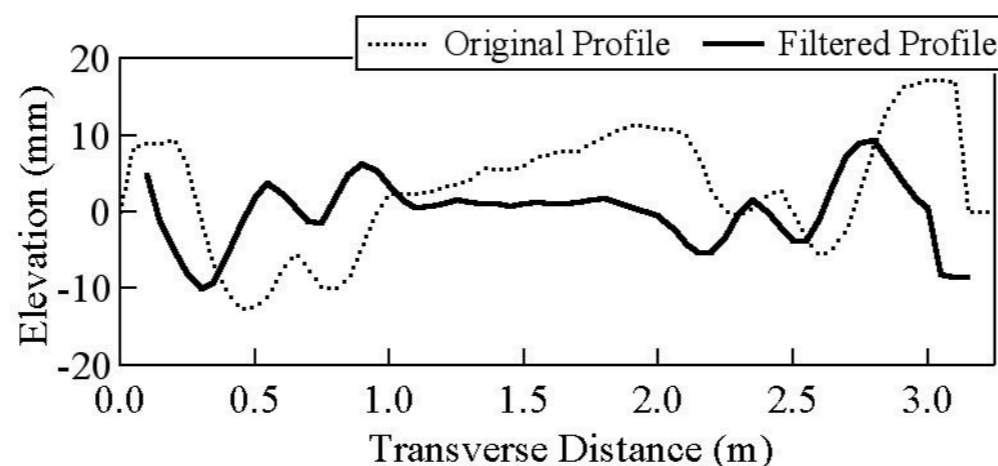

5. Index Development

❖ Wavy Characteristics Detection

Wavy characteristics of a profile have been identified



It is practical to directly detect specific wavelengths corresponding to the derived characteristics such as ride quality from the profile



Detecting wavy characteristics from a profile by a band-pass filter

❖ Band-Pass Difference Filter

The band-pass difference filter can be simply realized without the design for filter coefficients and convolution calculation.

$$y(n) = \frac{x(n + w/4\Delta d) - x(n - w/4\Delta d)}{2} \quad (n = 1, 2, 3, \dots)$$

$x(n)$: a series of profile elevation data (mm)

$y(n)$: filtered profile data (mm)

w : a detectable wavelength (m)

Δd : a detectable wavelength (m)

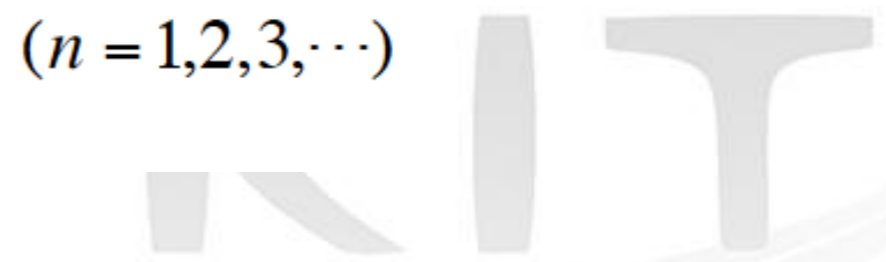

5. Index Development



❖ Response of the Designed Filter

The detectable wavelength w is set as **0.4m** (a wave number of 2.5m^{-1}) according to the results of the waveband analysis

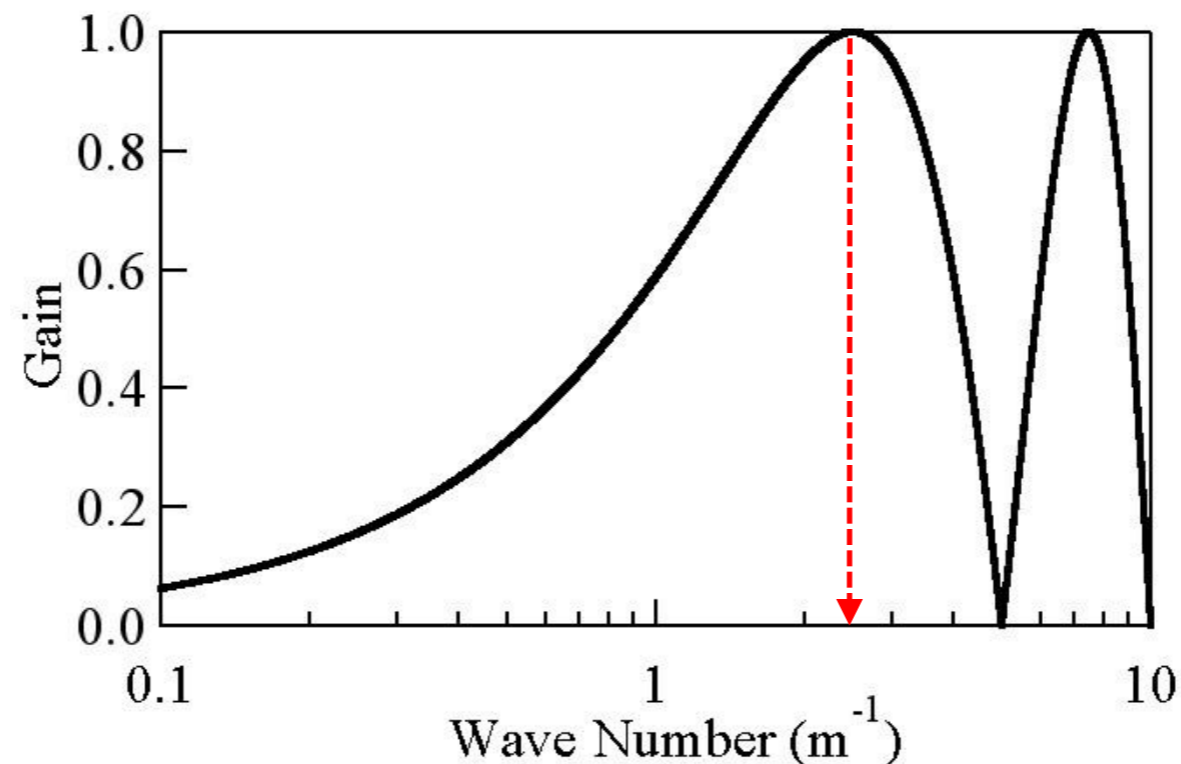

Wave Number Response of the Designed Band-Pass Difference Filter

* Although the filter has great sensitivity to sinusoids with a wave number of 8.0m^{-1} , rut profiles includes few wave numbers over 4.0m^{-1}

The designed filter emphasize the details of a transverse profile in the features of interest

5. Index Development

❖ A Band-Pass Filtered Profile

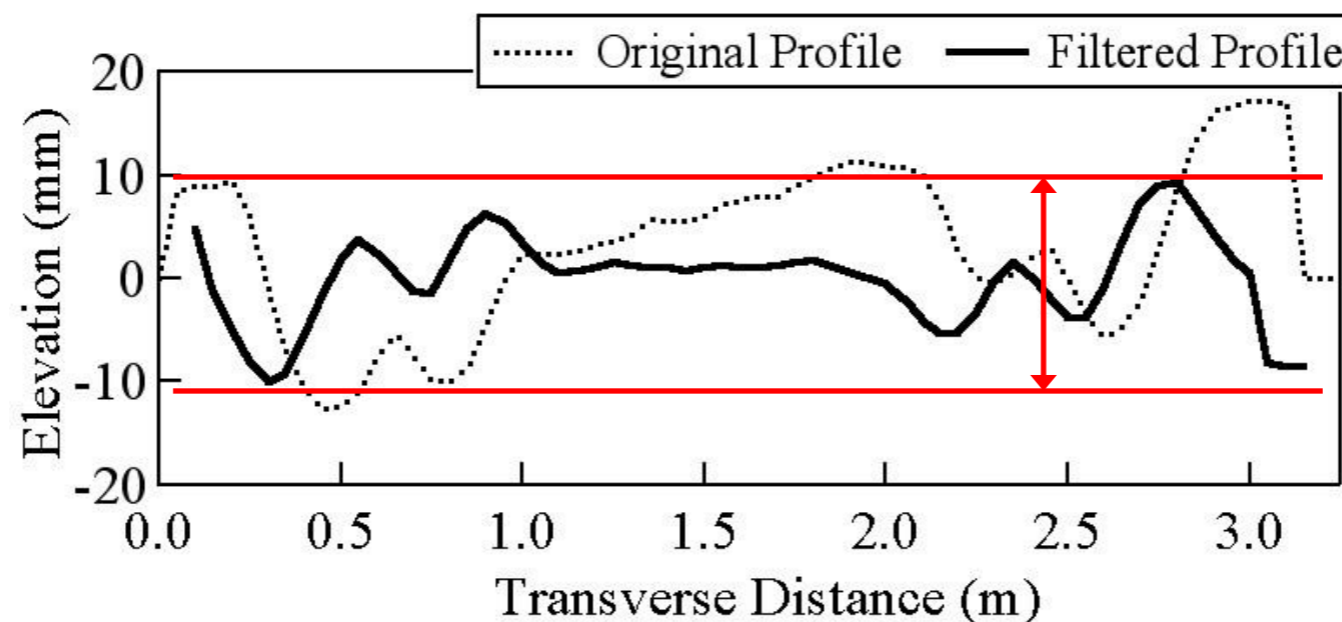

An Example of a Band-Pass Filtered profile

❖ Evaluation Index Development

- Adjusted Rut Depth: RD_{adj}
Maximum amplitude of a filtered profile
- Standard Deviation of Filtered Profile Heights: σ
- Root Mean Square of a Filtered Profile: RD_{RMS}

5. Index Development

❖ Correlation Analysis

The correlations of the HRD with the new indices of the filtered profiles and the traditional rut depth of the unfiltered profiles are considered

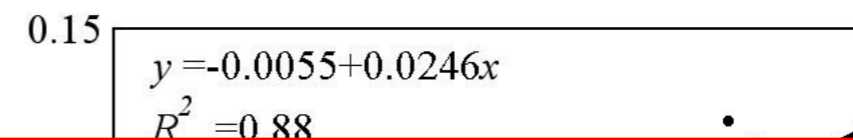
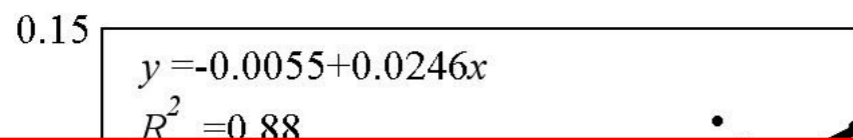
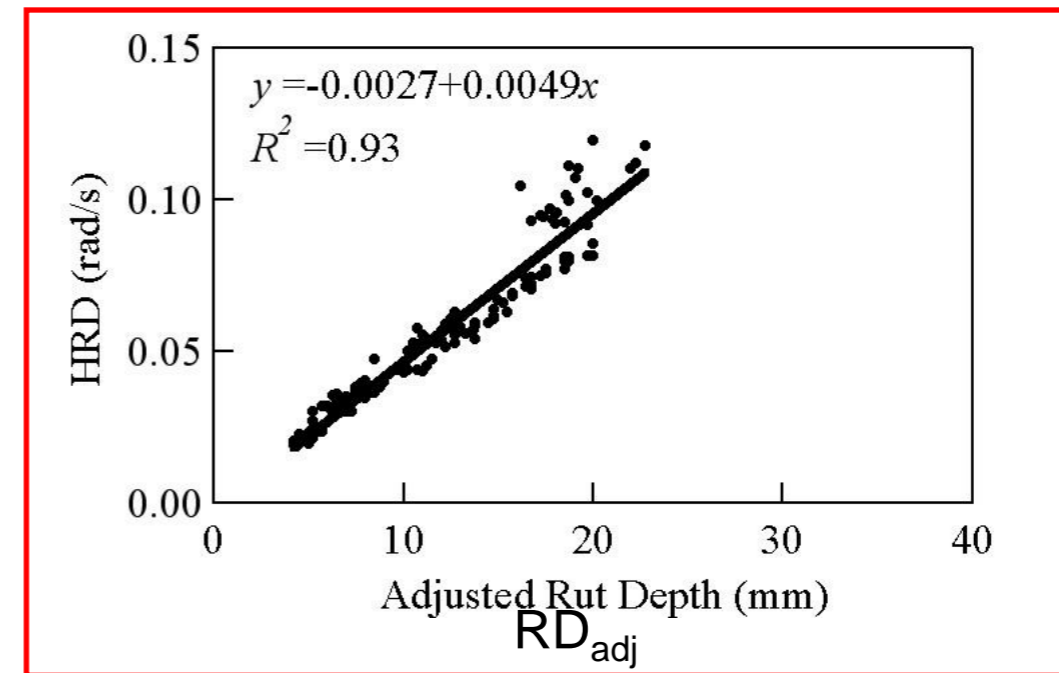
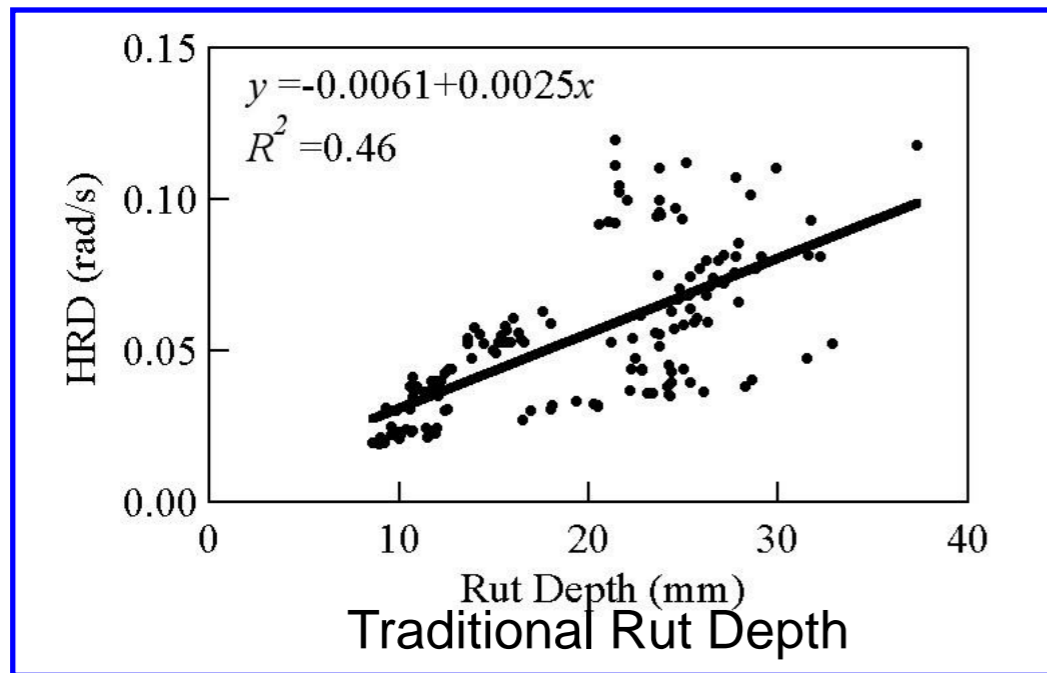

The adjusted rut depth is highly correlated with the HRD ($R^2 = 0.93$)

The adjusted rut depth helps to overcome the shortcoming of the rut depth by allowing road administrators to predict the ride quality of their rutted pavements

6. Conclusions

This study has developed a new evaluation index of rutting for the estimation of the ride quality of a road vehicle.

KITKITAMI INSTITUTE OF TECHNOLOGY

6. Conclusions



- ❖ The wavelengths 0.33-0.67m affect the vehicle motion, but in particular the wavelength of 0.4m seriously reduce the riding comfort of the vehicle motion.
- ❖ A band-pass difference filter is designed to enhance a wavelength of 0.4m and provides a filtered profile.
- ❖ The adjusted rut depth of filtered profile are closely correlated with the ride quality rating values expressed by the HRD.

The adjusted rut depth helps to overcome the shortcoming of the rut depth by allowing road administrators to predict the ride quality depending on the profile characteristics within the limited waveband.

Thank you for your kind attention!!

**Wavy Characteristics and Its Evaluation Index
Determining Ride Quality of Rut Profile**

**Tomiyaama, K., Kawamura, Ishida, T., and Jyomoto, M.
tomiyaka@mail.kitami-it.ac.jp**

Traffic Engineering Laboratory
Dept. of Civil & Environmental Engineering
Kitami Institute of Technology

