

EVALUATION OF DRIVER PERFORMANCE WHILE MAKING UNPROTECTED INTERSECTION TURNS UTILIZING NATURALISTIC DATA INTEGRATION

**Sudipto Aich
08/29/2012**



THE METHODOLOGY FOR THE EVALUATION OF DRIVER PERFORMANCE WHILE MAKING UNPROTECTED INTERSECTION TURNS UTILIZING NATURALISTIC DATA INTEGRATION

**Sudipto Aich
08/29/2012**



Initial Roadmap in support for this Research

- Funding for this project came from the National Surface Transportation Safety Center for Excellence (STSCE).
 - Phase 1: Investigate set of hypotheses about older driver scan patterns and attention deployment in approaching turns. PI: Linda Angell/ Jon Antin.
 - Phase 2: Additional funding aimed to support Master's thesis to investigate an additional research hypothesis.
- Related projects: Toyota-sponsored follow-on study of glance-related behavior (head rotations) at intersections for older drivers compared with middle-aged drivers (at identical intersections & pathways) led by Jon Antin.

Why Intersection related crashes are a cause of concern?

- Over 2.4 million vehicle crashes were intersection related*
- Further, intersection crashes contribute to 40 % of total crashes *
- The contribution of Intersection crashes go up to 47% if the unknown crashes are not considered. A jump from 21% in 1999#
- This over-representation of intersection crashes, relative to the total number of crashes makes driving behavior at intersections a traffic safety issue

*Source: * FHWA. (2009). The National Intersection Safety Problem. Intersection Safety Issue Briefs, U.S. Department of Transportation, Federal Highway Administration, Washington D.C.*

NHTSA. (2010). Traffic Safety Facts: 2009. U.S. Department of Transportation. Washington D.C.: National Highway Traffic Safety Administration.



Age- Groups at Risk

Older Drivers

- Suggested by overall crash data. More so for INTERSECTIONS
- AGING brings about physical and mental changes which makes Driving difficult task
- CRASH SURVIVABILITY questionable esp. as more angled/side impact crashes

Younger Drivers

- LACK EXPERIENCE when making critical driving related decision
- ELEVATED RISK TAKING ATTITUDE: Speeding, Not Wearing Seat-belt amongst others
- DRIVER INATTENTION – More prone to engaging in Secondary Task , and over-estimation of abilities

Scope for this Research

- **Data obtained through the integration of 2 Naturalistic Driving studies.** Unique opportunity to answer post-hoc research questions.
- **Unprotected/Uncontrolled Turns** (Like Yield, One-Way Stop Sign turning into through traffic, No Signage) were the focus.
 - Primary focus around driver decision/indecision and not 'Right of Way'

Key Variables of Interest

- **Gap Acceptance/Not-Acceptance** have been studied outside the vehicle observation studies
 - No interaction with other driver behavior and other age related differences
- How the presence of other vehicles at an intersection affects **Driver Performance**
 - Whether **traffic density** interacts with age effects
 - **Visual strategies** required to safely make unprotected turns
- **Kinematic Data** to aid better understanding Driver Habits across different age-range

Process Chart for Data Mining Aggregation

STEP 1: Data Availability

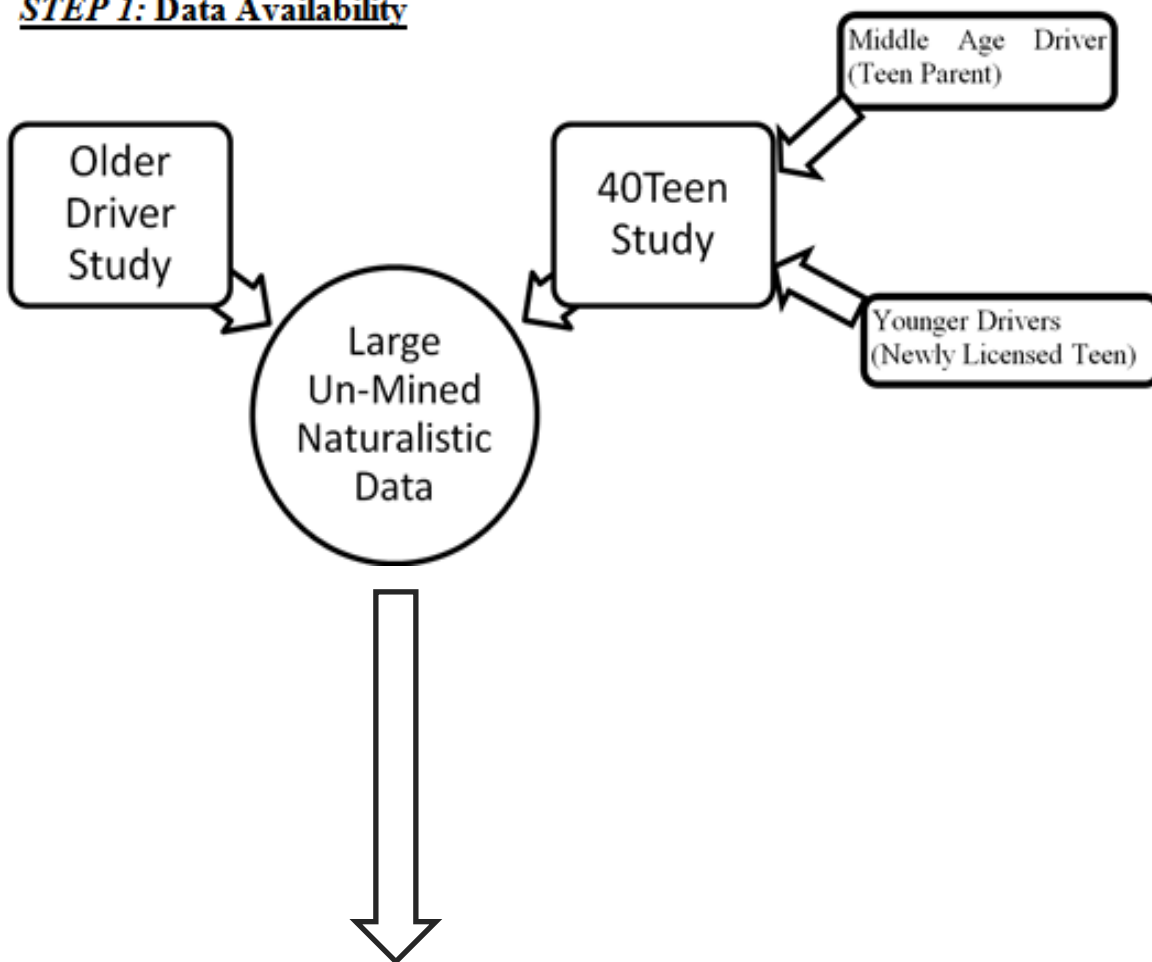

Two naturalistic datasets were used:

Older Driver Study

- 20 Drivers b/w ages of 71 – 84 yrs
- Driving for *12 months*
- *30,000 trip* representing over *4600 hours* of driving data

40 Teen Study

- *42 newly licensed teen drivers* 16 years of age during their first *18 months* of independent driving
- The study also included the *Parents* of the Teen as *secondary drivers*
- *500,000 miles* in nearly *102,000 trip* files, with approximately *17,000 hours* of data

STEP 2: Data Mining Algorithm

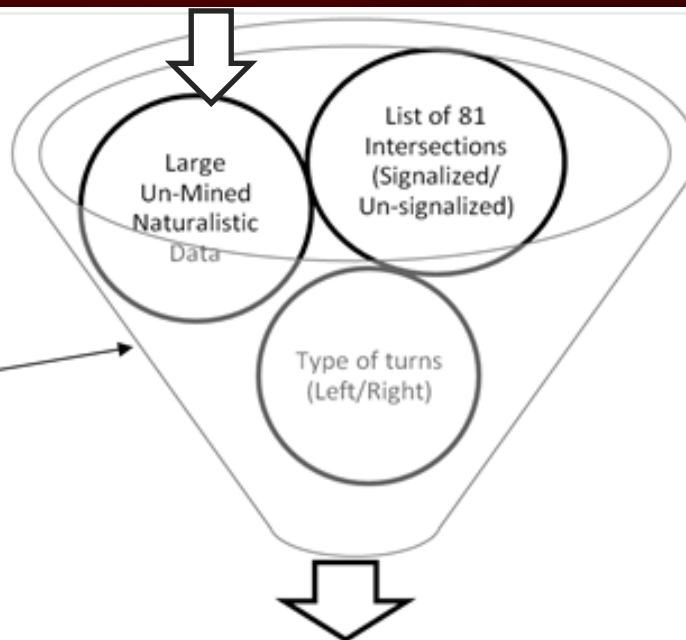

Aggregated Data

STEP 3: Data Reduction

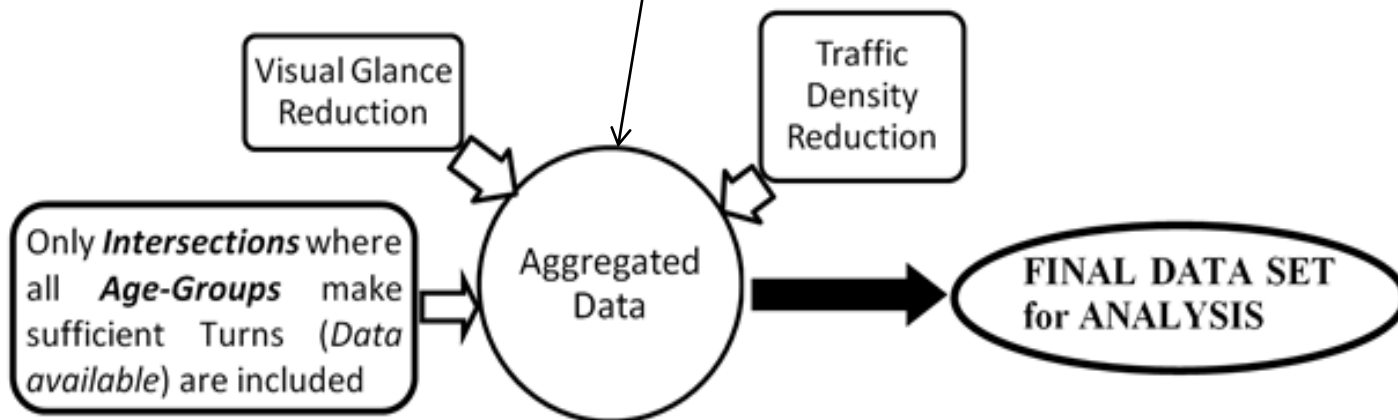

Data Acquisition System

Rear-facing camera
mounted near CHMSL
also captures left of vehicle

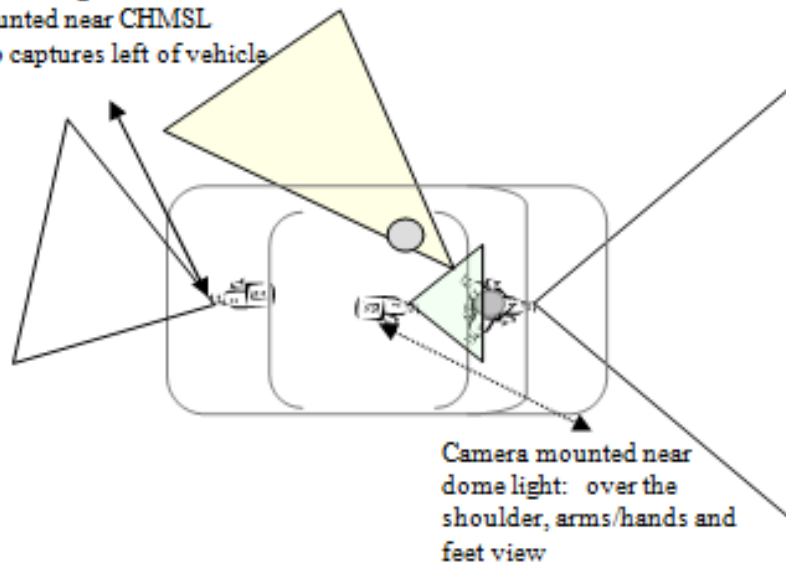

DATA MINING ALGORITHM

Latitude and Longitude of a Point

Note: Right click on a **blue marker** to remove it.

Get the Latitude and Longitude of a Point

When you click on the map, move the marker or enter an address the latitude and longitude coordinates of the point are inserted in the boxes below.

Latitude:

Longitude:

Show Point from Latitude and Longitude

Use this if you know the latitude and longitude coordinates of a point and want to see where on the map the point is.

Use: + for N Lat or E Long - for S Lat or W Long.

Example: +40.689060 -74.044636

Note: Your entry should not have any embedded spaces.

Decimal Deg. Latitude:

Decimal Deg. Longitude:

STEP 1

- On a map find leg-points (0,1,2,3,4) to each individual intersection
- GPS Location of each of those individual leg-points is obtained
- A Master list of all intersection location along with the intersection type, location is created. 81 Intersections were identified based on driver location, crash propensity (if data available), and intersection type.

DATA MINING ALGORITHM *contd...*

• STEP 2

- A data mining algorithm was used to compare the compiled list of intersection co-ordinates with all the trips available in the two databases.

Database	Trip Id	<u>TimeSync</u>	Vehicle Number	Intersection number	Intersection Legpoint	Distance (Ft)
Older Driver	12	840	1	2	1	6.02572
Older Driver	12	870	1	2	0	15.40987
Older Driver	12	920	1	2	3	9.937178
Older Driver	12	1150	1	1	1	12.70175
Older Driver	12	1200	1	1	0	12.54777
Older Driver	12	1229	1	1	3	13.65183
40 Teen	2	3360	1	13	4	10.85953
40 Teen	2	3411	1	13	0	25.60811
40 Teen	2	3431	1	13	2	11.87241
Older Driver	12	4166	1	10	1	8.064499
Older Driver	12	4476	1	10	0	4.23344
Older Driver	12	4566	1	10	3	9.31955
40 Teen	11	9921	1	9	3	7.944183
40 Teen	11	10311	1	9	0	9.732666
40 Teen	11	10390	1	9	1	6.475656

Initial Intersections List

North Main meets Prices Fork



Patrick Henry meets Harding Ave.



Stop Sign

Selected One: Unsignalized Left Turn Intersection

Patrick Henry meets Harding Ave

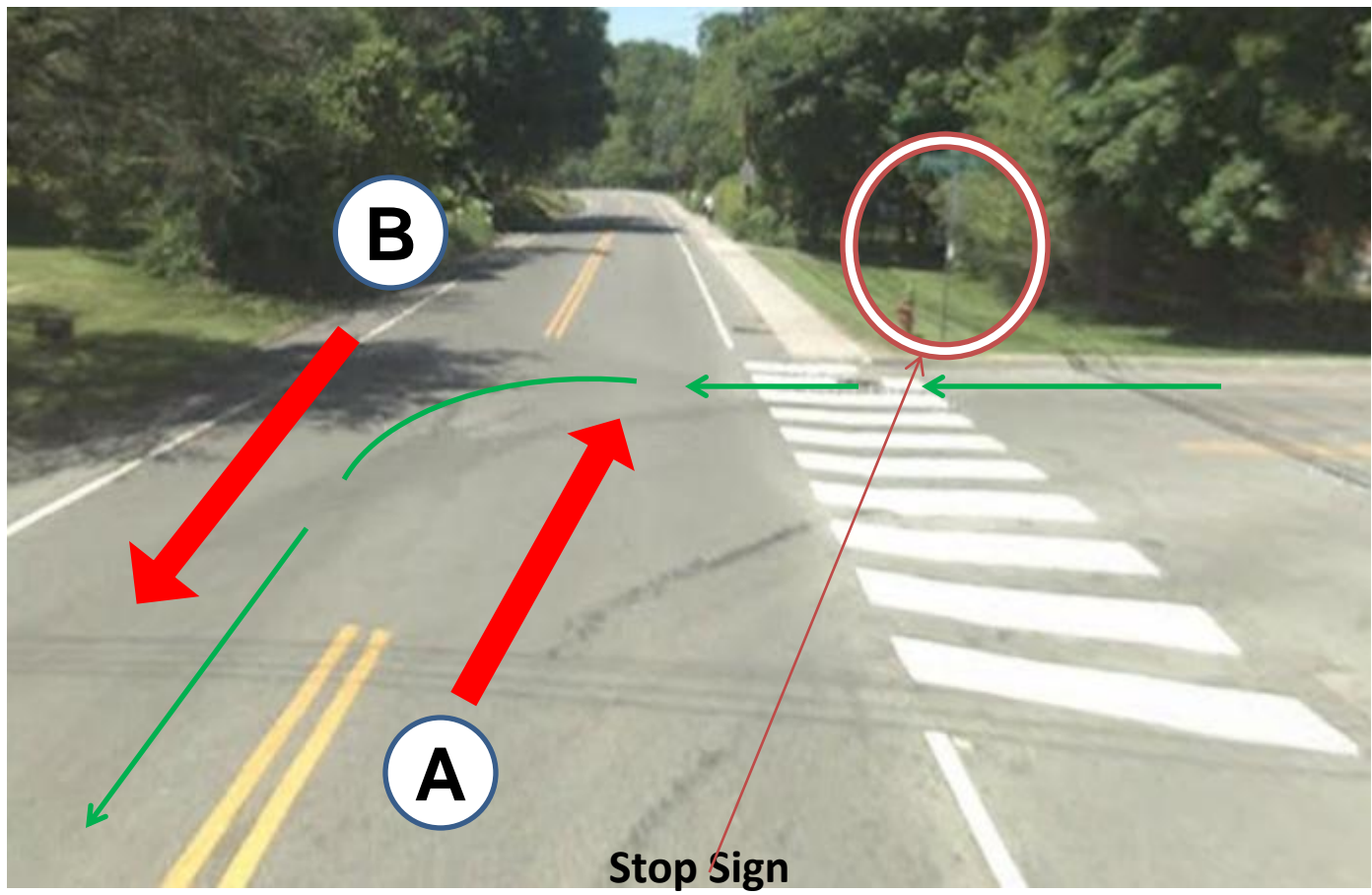

Selected One: Unsignalized Right Turn Intersection

Patrick Henry meets Harding Ave

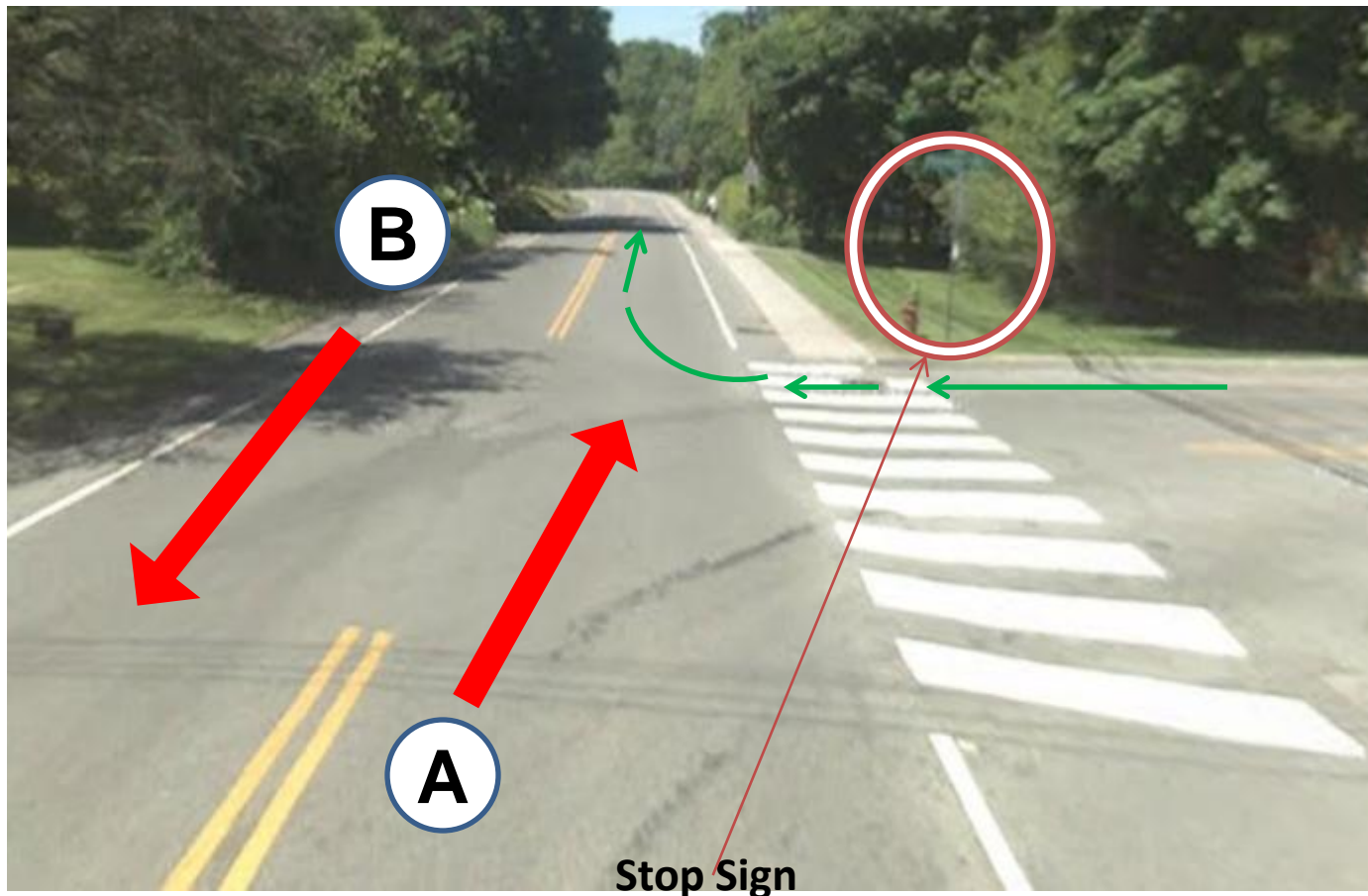

Output Data after Secondary Search Algorithm Before Data Reduction

Driver →	Teen Driver →		Parent Driver		Older Driver	
	Unique Participants	Total Number of Trip Files	Unique Participants	Total Number of Trip Files	Unique Participants	Total Number of Trip Files
Right Turn	17	530	12	141	8	43
Left Turn	15	159	7	33	10	31

DATA MINING ALGORITHM

- **A new algorithm was developed** to find and match a left-turn and right-turn at the same intersection.
 - A combined total of **142,000 trips** with more than **22,000 hours** of data was searched by this algorithm
 - This predicted around **1638 trip files- with about 600 hrs. of data**
- **Data was analyzed through a Cluster**, which decreased batch processing time for the whole data
- **A secondary search algorithm** was used to mine the 1638 trip files to clear unwanted trips with un-synced timestamp, unavailable video, or erroneous data was used.
 - A final list of **937 trip files** were obtained, approximately **345 hrs. of driving data**
- **The final search algorithm yielded 345 hrs. of relevant driving data**, which meant that the whole database was searched and **only 1.6% of the total available data** was used for the purposes of the research.
- **Selection of resulting trips and extraction of independent and dependent variables.** The next step was to individually assess the data and to separate trip files which would be needed to answer the proposed research questions.



DATA REDUCTION *contd...*

• Video Reduction

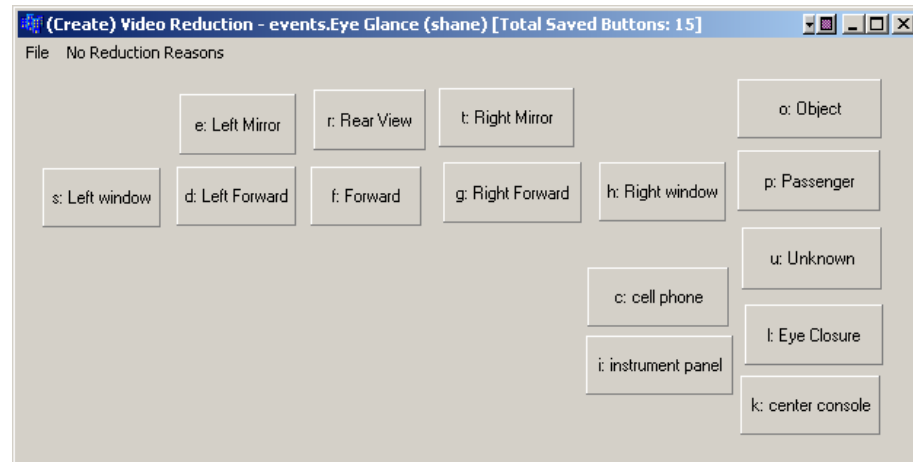

- Video Reduction helped in conforming the algorithms accuracy
- Event epochs were also confirmed using the driver video
- Traffic density reduction
- Gap Acceptance times will also be found using the timestamp of the video
 - Forward camera to observe when the leading car passes and note the time
 - Rear Camera to observe the next passing vehicle on the intersecting stream at the intersection and note the time

TRAFFIC REDUCTION

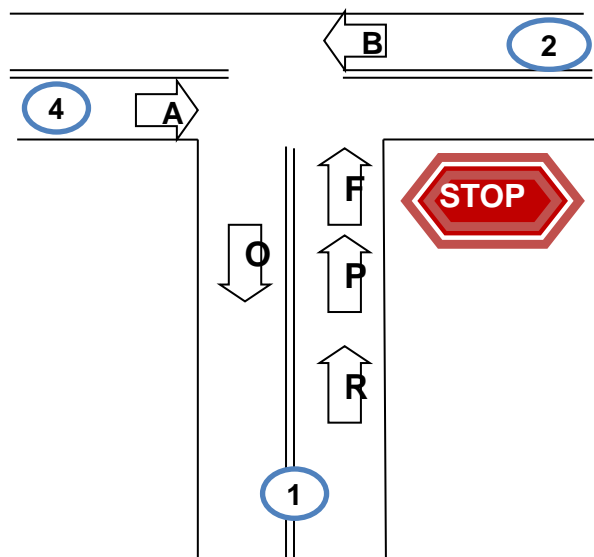

CODE	CODE DEFINITION
P	Subject vehicle
1,2,4	Direction Markers (Heading)
R	# of cars behind the subject vehicle at the time of departure from the intersection
F	# of Vehicles in front of the subject vehicle when it comes to a stop for the first time while approaching the intersection
A	# of vehicles coming from 4 and continues to head towards 2
B	# of vehicles coming from 2 and continues to head towards 4
BO	# of vehicles coming from B making a turn towards O
AO	# of vehicles coming from A-4 making a turn towards 1)
O	# of vehicles in the opposite lane that passed the subject vehicle while its waiting at the entire duration of the stop sign
<i>Note: The code O will be used in instances where it is not possible to assign a vehicle under either AO or BO, i.e., what turn a certain vehicle made</i>	

TRAFFIC REDUCTION

Traffic Presence Coding was done utilizing the Video Available from the Naturalistic Driving Files. For the Intersection Chosen , below is the coding illustration

- There were 4 identified traffic coding:
 - Traffic at all streams i.e A/AO and B/BO
 - Traffic from only Left Stream i.e A /AO
 - Traffic from only Right Stream i.e B/BO
 - No Traffic at intersecting streams

- So the resulting coding for only 2 levels dictated by data:
 - Traffic Present: When vehicles from A and B streams
 - No Traffic Present: When no vehicles from A and B

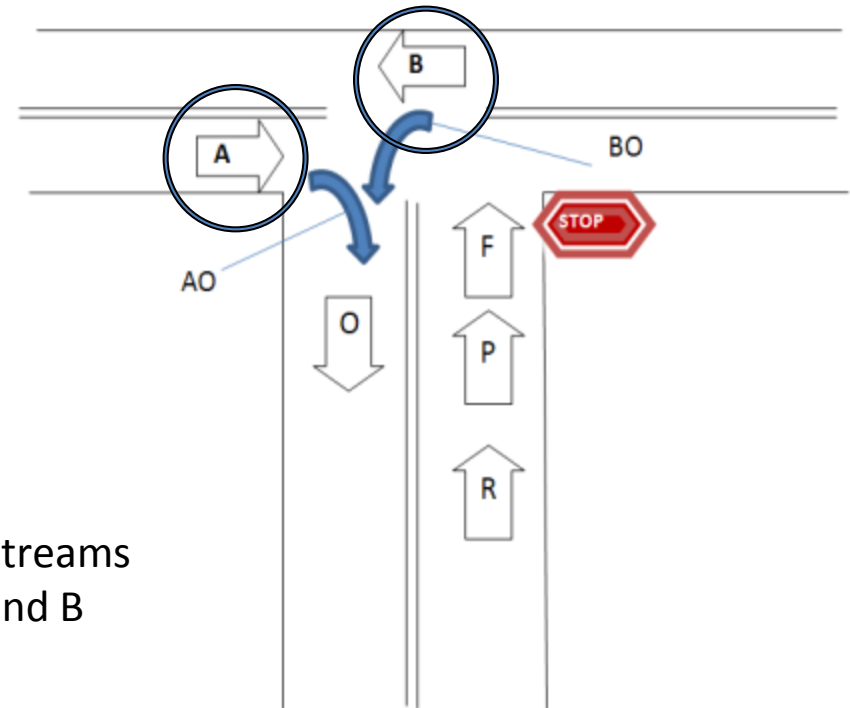

GAP ACCEPTANCE AND REJECTION

- Gap-acceptance is the process in which a driver of a vehicle accepts the (critical gap) time presented to him/her as sufficient, to start to initiate a turn maneuver and subsequently complete it.

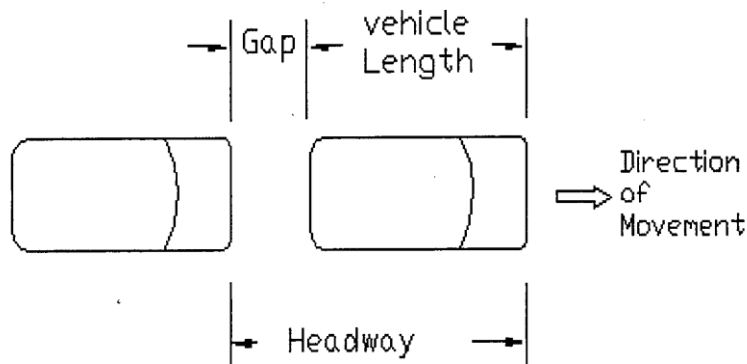

Time-Space Interval

Time

Source: Highway Capacity Manual, 2000

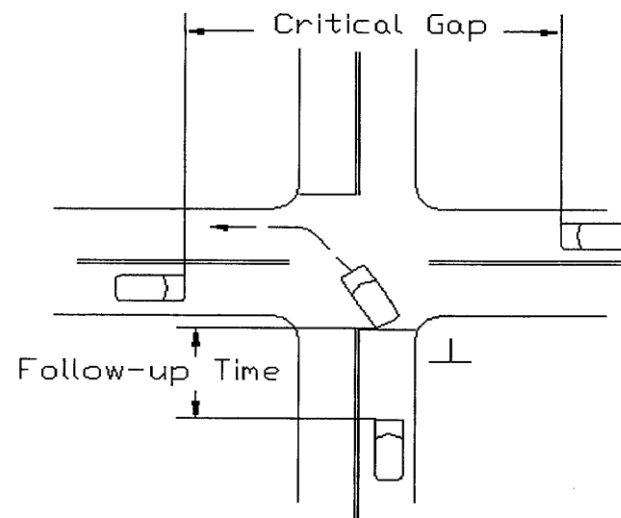

up

Source: Gattis & Low, 1998

- Misjudgment of Gap is a major concern for drivers making intersection turns.
- Drivers above age 70 are much less likely to accept shorter gaps when compared to other drivers (Zhou, Lownes, Ivan, Ravishanker, & Gårder, 2009)

GAP ACCPETANCE AND REJECTION

- The various gap times were coded separately using the video
- It is also of importance to know how approaching traffic tends to effect kinematic behavior

From the Diagram on the Right

Available Gap for right turn:

- A-1 and A-2

Available Gap for Left Turn:

- Passage of time between A-1 and A-2
- Passage of time between B-1 and B-2
- Passage of time between B and A

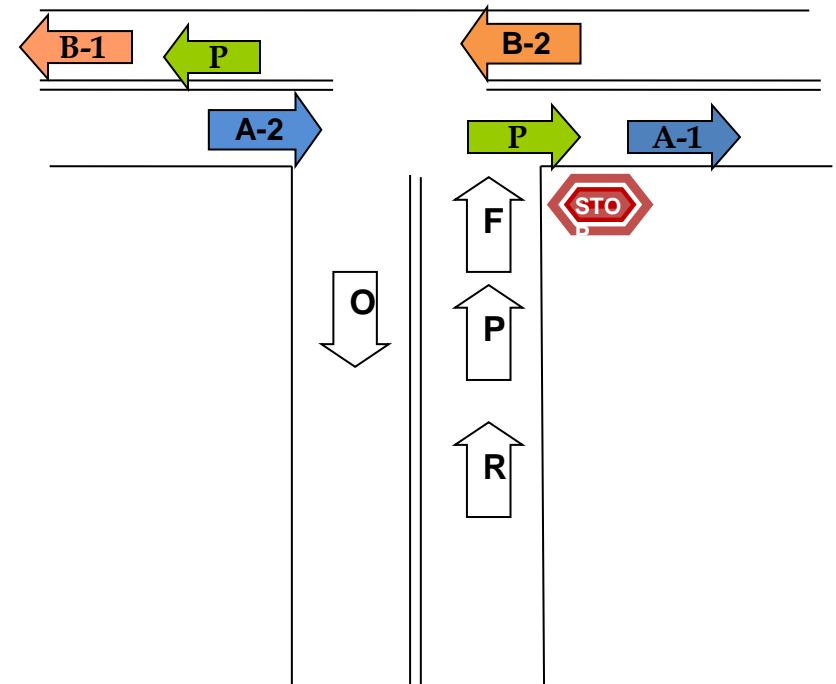

- Files were sorted for instances where the drivers accepted gaps (and also considered files where drivers rejected gaps as too small)

VISUAL PERFORMANCE

- 90% of driving information is captured through the eye (Robinson, Erickson, Thurston, & Clark, 1972)
- 44.1% of all intersection crashes are caused due to inadequate surveillance (NHTSA, 2009)
- Teens are more willing to engage in secondary task (like Text Messaging), thereby more prone to taking eyes off-road (Olsen et.al, 2009)
- Even though Teens are more at risk in regular driving situations, it is the Older individuals who are at risk when negotiating intersections. Why?
 - Loss of visual acuity and contrast sensitivity (Burg, 1967) (Ball K. O., 1993)
 - Wrong Glances- check more mirrors/windows then the task requiring glances compared to adults (Lee, Olsen, & Simons-Morton, 2006)
 - A Stability-Ratio used to estimate scanning stability found Lacking stability on Areas-of-Interest when compared to younger drivers who scanned evenly (Maltz & Shinar, 1999).

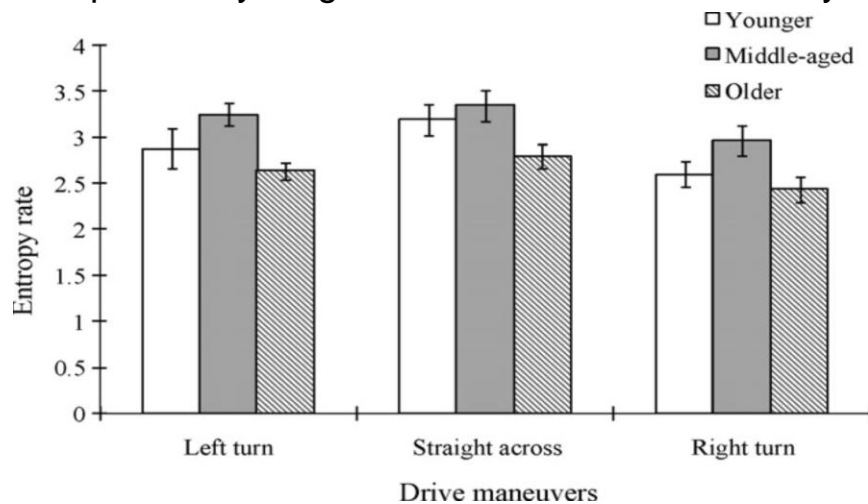

*Visual Entropy Rates for Visual Scanning with error bars,
Source: (Boa & Boyle, 2008)*

VISUAL PERFORMANCE

Visual Glance Entropy diagram that was constructed as part of this Research

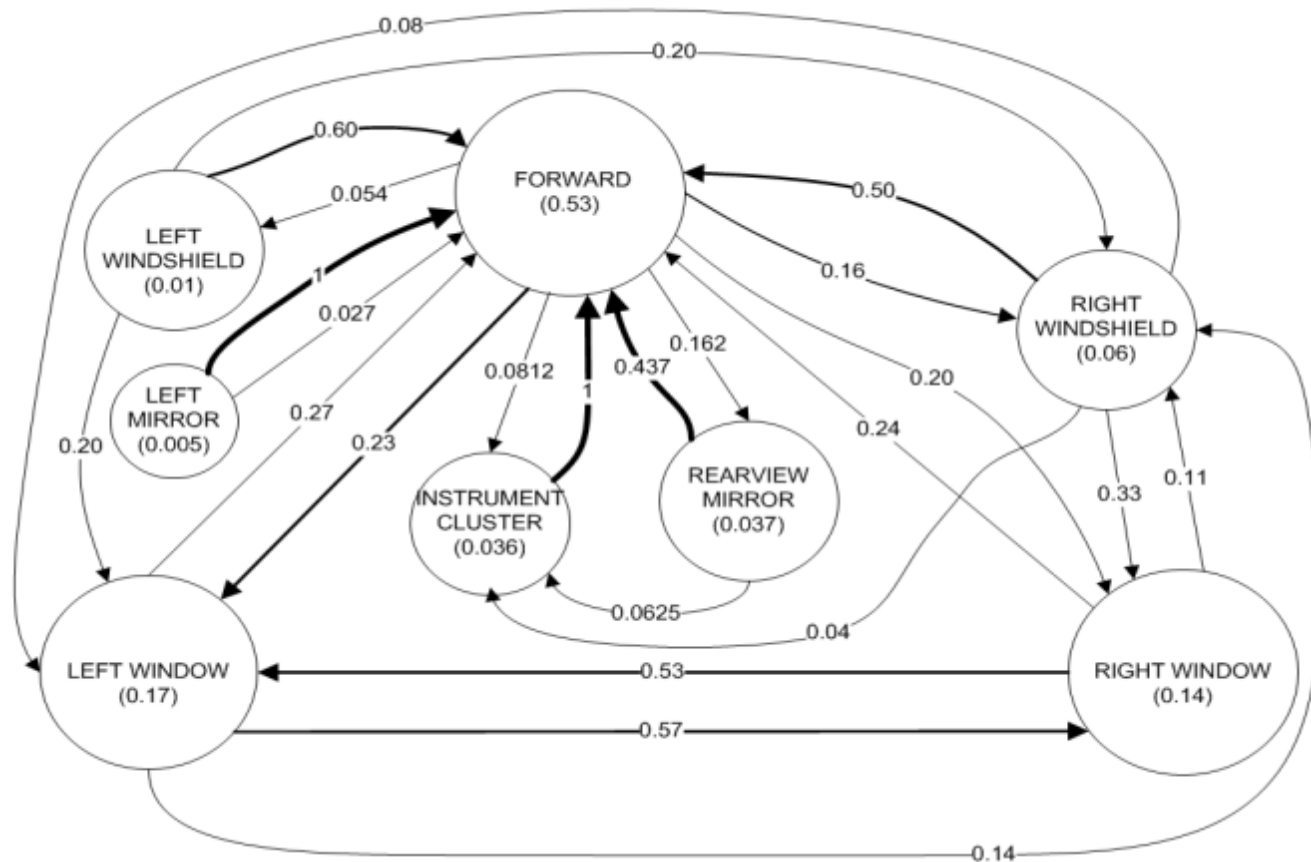

VISUAL PERFORMANCE

Driver Visual Behavior Shape Modeling based on the event data through an intersection.

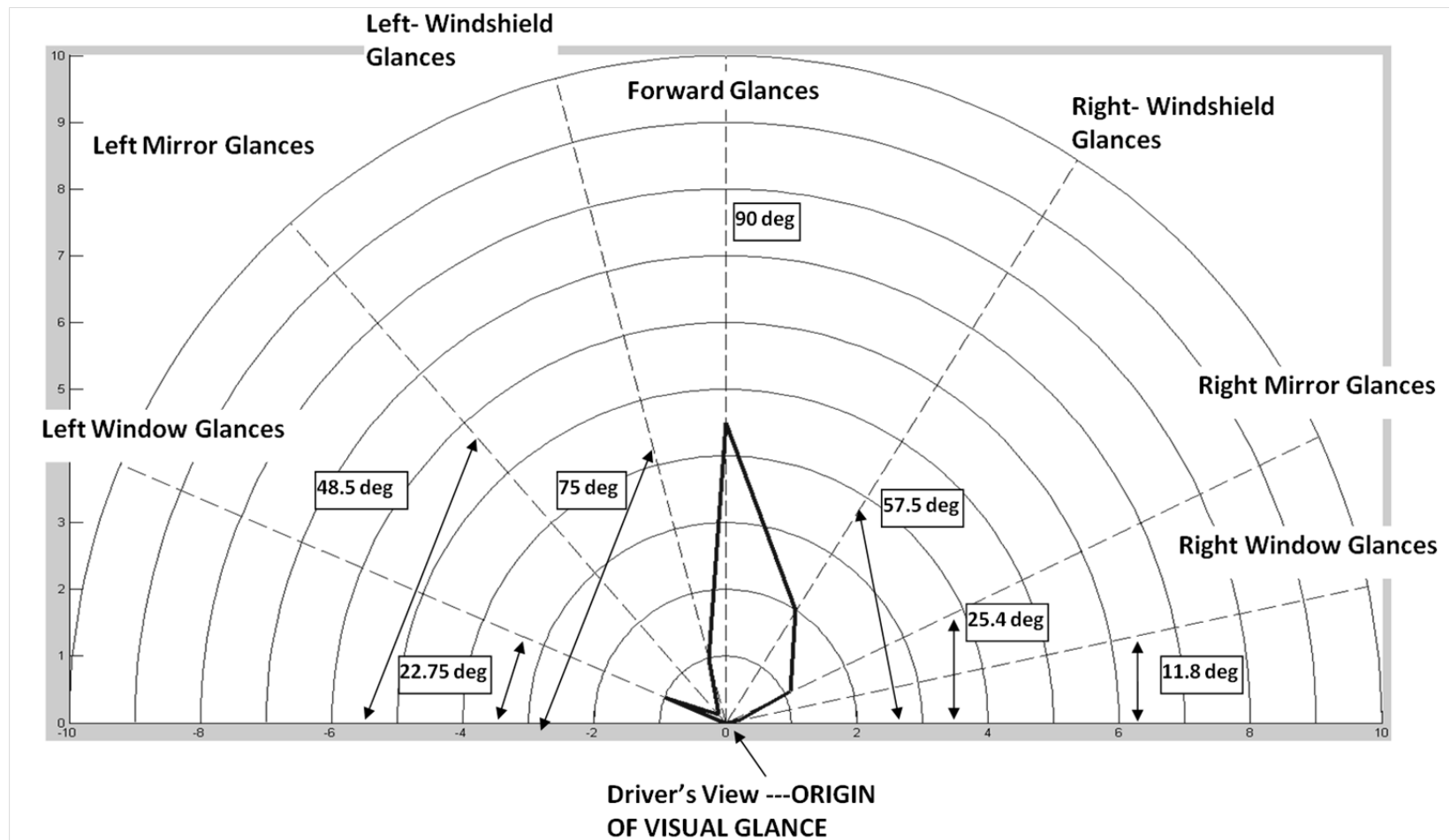

Kinematic Variables

- Kinematic Patterns – How Drivers Initiate, Make, and Complete their Turns.
- Variables of interest
 - Peak Speed through the intersection turn
 - Peak Longitudinal Acceleration
 - Peak Lateral Acceleration
 - Average Speed

Contribution

- This work explores the idea of answering **Post-hoc Research Questions** through Naturalistic Data mining approaches.
 - New Driver Assist Feature
 - Driver Training
- **More Data is less data**, even though 143,000 driver trips were used, intersection scenarios of unprotected nature were fewer.
- The **research found a void in driving performance exist** predominantly between the Older and the Younger driver group.
 - More so the exploration of traffic levels, gap acceptance, gap non-acceptance were exploratory efforts, one **that ventures into new areas of technical content, using available naturalistic driving data**
- The **Second Strategic Highway Research Program (SHRP 2)** has potential to fill the data void that the previously collected Naturalistic Data could not.

END

Questions/ Comments

Sudipto Aich

Research Engineer

Vehicle Design & Infotronics

Research & Advanced Engineering

Ford Motor Company

Research & Innovation Center (RIC)

2101 Village Rd, Dearborn, MI 48121

Mail Drop: 3137

Tel: 313-323-7942

Fax: 313-337-5581

saich@ford.com

WE
GO FURTHER
SO YOU CAN!

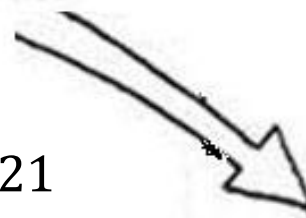

Thank You

VTTI (NSTSCE)



Backup Slides



LEFT TURNS

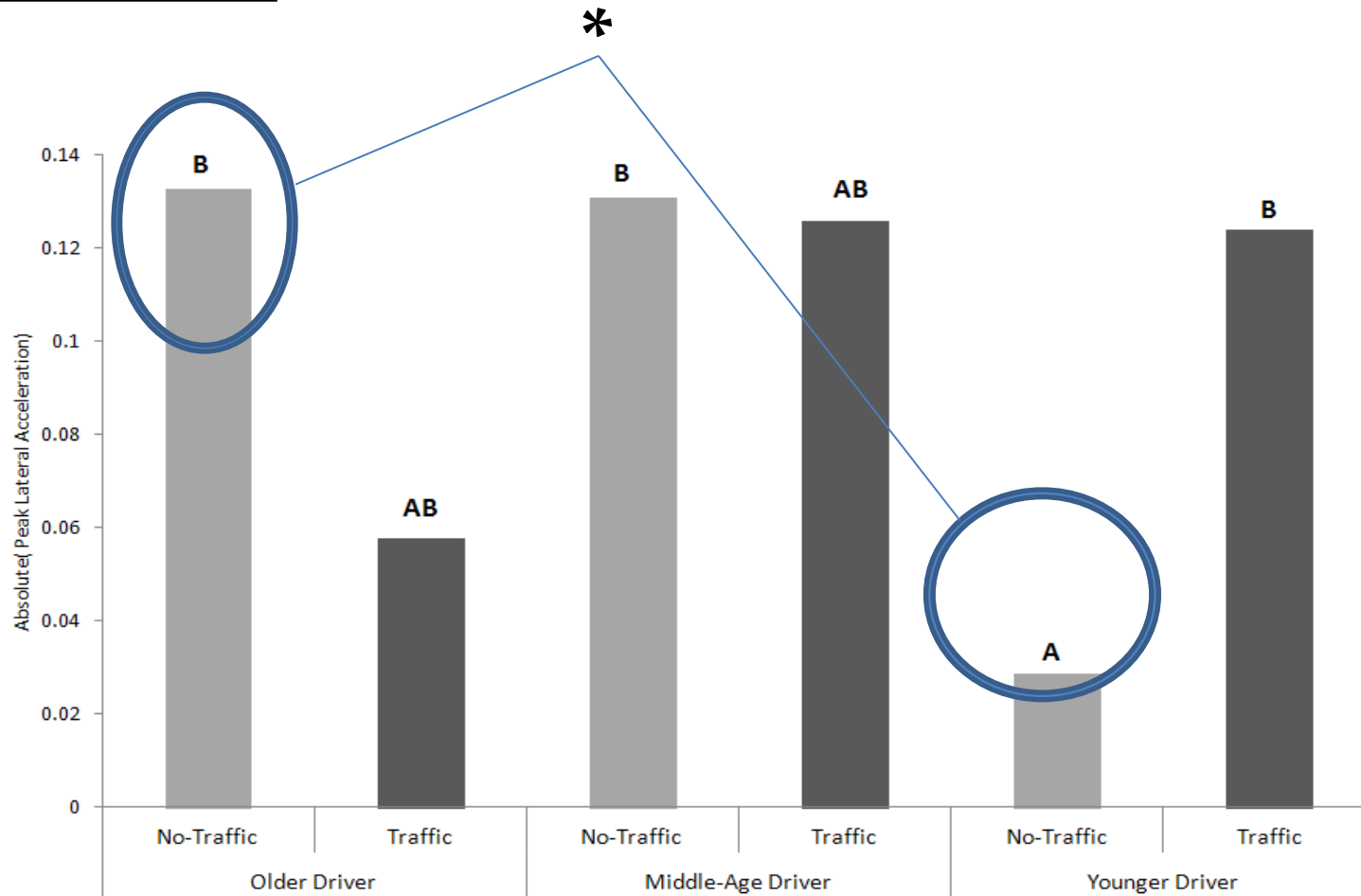

LEFT TURNS

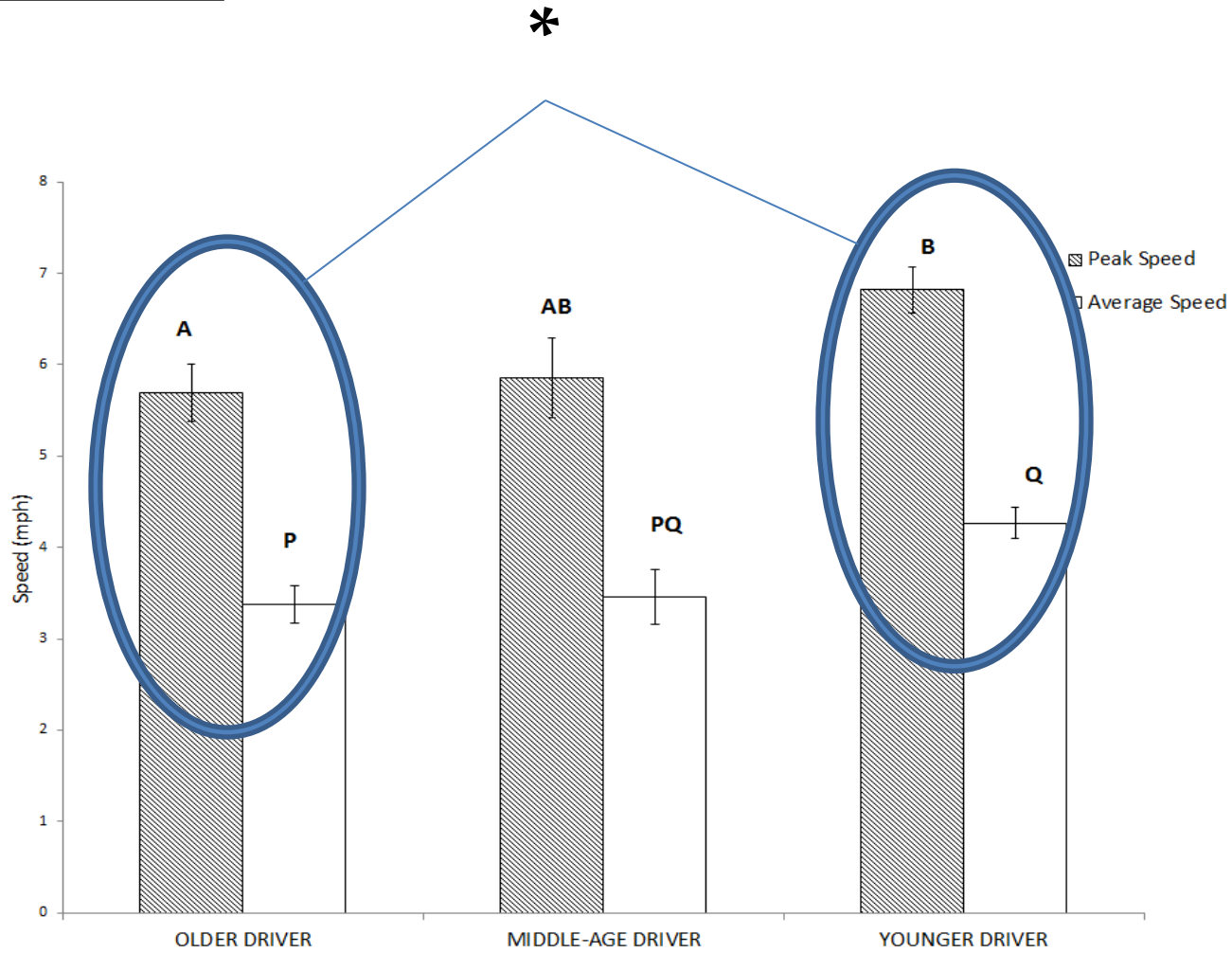

AVERAGE GAP/NOT ACCEPTED GAP times for Drivers

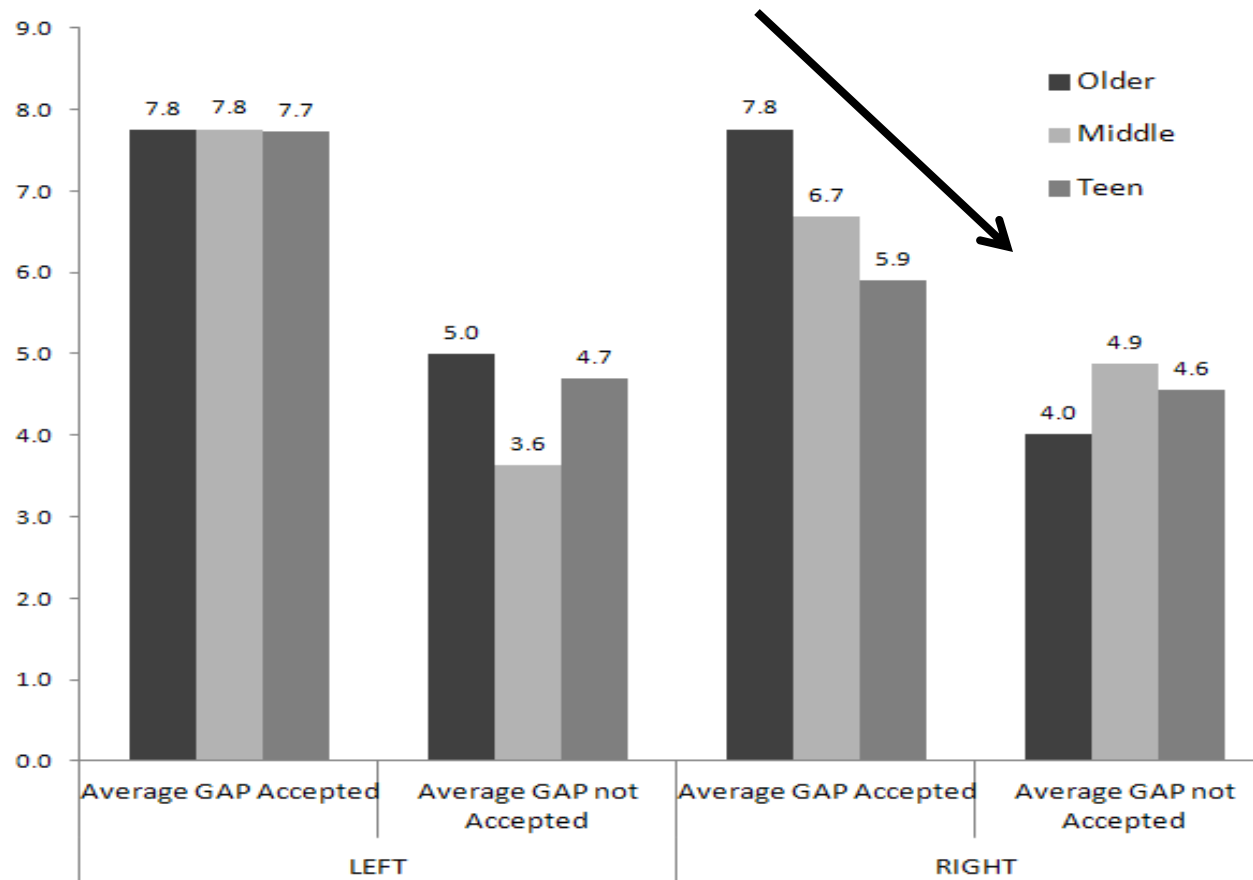

SMALLEST GAPS that DRIVERS ACCEPTED in NATURALISTIC DRIVING

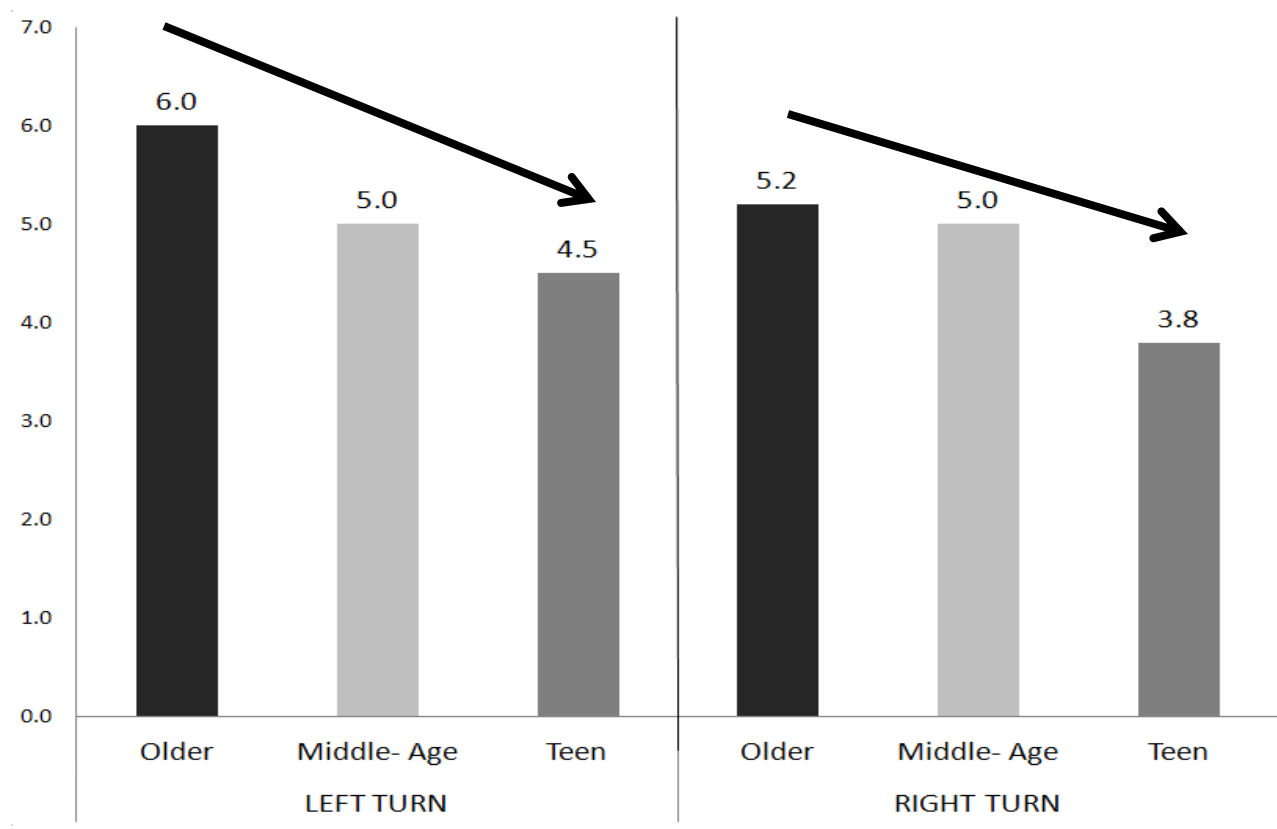

Coding of Glance Locations

'Tools Developed at VTTI were used by trained reductionists to do eye glance reduction'

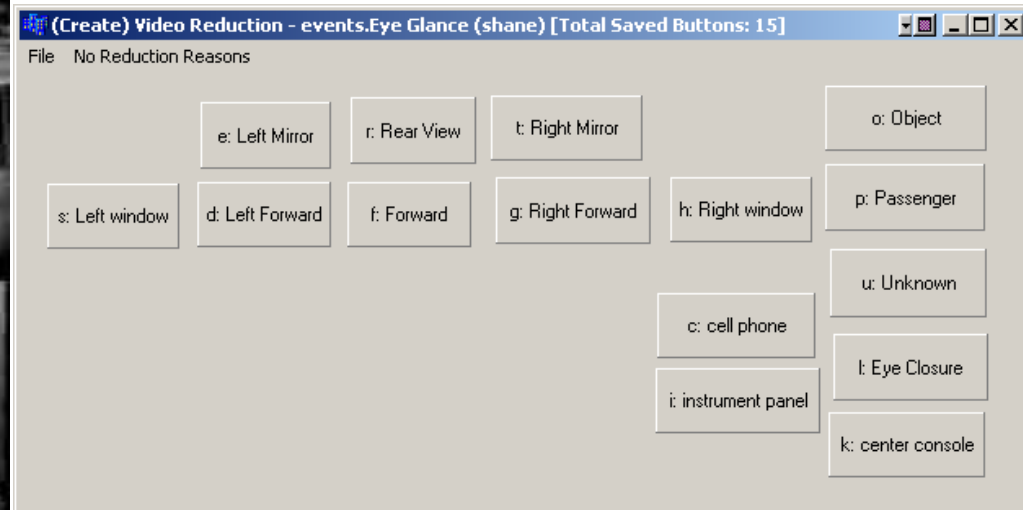

Research Questions

Research Question 1

How do drivers regulate their visual glances while making unprotected turns?

Hypothesis 1

- *The presence of traffic at the intersection increases the amount of visual scanning that driver's exhibit prior to initiation of their turns for all age groups. However, Older driver's visual patterns will still be spatially narrower than for drivers of other ages.*

Hypothesis 2

- *Older drivers will have longer fixated glance durations in comparison to the teen driver*

Research Question 2

How do drivers manipulate their gap acceptance levels across age groups?

Hypothesis 3

- *The younger driver group will accept lesser gaps in traffic to make unprotected turns when compared to other age groups*

Hypothesis 4

- *Older driver group need significantly larger gaps to make unprotected turns and will reject smaller gaps available compared to other drivers*

Research Question 3

Are there age-related differences in driving kinematics while making turns at the intersections?

Hypothesis 5

- *The Younger Driver group will exhibit higher kinematic values (lateral & longitudinal accelerations, mean speed etc.) in their initiation, execution, and completion of their turns compared to the other driver groups*

Hypothesis 6

- *Older driver group will exhibit more cautious and lower kinematic values in their initiation, execution, and completion of their turns (e.g., taking more time to be certain of decisions) – and this tendency toward slow responding will be amplified in the presence of other traffic.*

- Entropy analysis revealed that there is a significant difference between entropy values of drivers in the presence or absence of traffic for left turns and approaching significance value for right turns.
- Further, younger teen drivers had lower entropy compared to other drivers in no-traffic conditions, but also had the highest entropy compared to other drivers in traffic condition.

GAP ACCPETANCE AND REJECTION

- Files were sorted for instances where the drivers accepted gaps (and also considered files where drivers rejected gaps as too small)
- Accepting a gap meant that after the driver made the turn he had a vehicle closing on him
- Individual Experimental Design Blocks for each turn were created to perform analyses -- to see if Accepted/Not-Accepted Gap times differ across driver ages

Relatedness Among Parent and Teen Drivers & Other Issues In the Data

- **Familial Ties and Driving Behavior Similarity.**
 - All familial ties between the *younger teen driver* and their *parents* (that were possible in the 40-teen dataset) have been *avoided*
 - Although for the Left turn made at the Unsignalized intersection, one *Husband and Wife pair are included*. However, the literature gives no reason to expect similarities between driving behavior between pairs related only by marriage (and not by parent-child relationship, through which values-transmission or driving instruction might have occurred).
- **Illumination under driving conditions.**
 - Nearly all files are *Daytime files* and any night-time file instances are identified and separated.
- **Gender effects.**
 - Gender has not been included as a variable in this study. However, studying *gender effects* might be a possibility for later analysis, by pooling all age-groups together.

Scope for New Research Study *contd....*

- **Naturalistic Form of Data Collection**
 - Most Controlled experiments take place in artificial study settings, and lack external validity with respect to true capture of driver (participant) behavior
 - Even though there has been a shift from the simulator to the real car for on-road studies, there is often still a lack of traffic or only a partial representation of the driving environment
 - Naturalistic driving observation is an unobtrusive method to observe various driver behaviors
 - Participants get their own vehicles equipped with devices that, for a considerable length of time, continuously monitor various aspects of driving behavior, including vehicle movements, behavior of the driver, and characteristics of the environment



Scope for New Research Study *contd....*

- **Naturalistic Form of Data Collection** *contd....*

- The Virginia Tech Transportation Institute (VTTI)

2 Naturalistic Driving studies were chosen as a source of data for use in the thesis work proposed here. No known prior studies on unprotected turns at intersections have been done with data from naturalistic driving

- All participants' cars were fitted with multiple cameras, sensors, and a processing unit that collected video and parametric data regarding participants' normal, daily driving. The overall data collection lasted for over a period of 12-13 months per vehicle and captured over 2,000,000 vehicle miles of driving, 42,300 hours of driving data.



How Drivers Behave At Intersections

(Unprotected Intersections)

- **Aging drivers are historically over-represented in multi-vehicle angled impact crashes** (resulting from turns at intersections) & have a higher rate of fatality than younger drivers.
 - Staplin et al (2001) reported that 48-55% of all fatal crashes involving drivers aged 80 years or over occurred at intersections
 - This was more than twice the rate for drivers under the age of 50 years (23%)
- **This area of crash risk remains a significant one for older drivers**, even though a recent study by IIHS (in 2008) revealed drops in these rates for older drivers (due, it is thought, to self-limiting of driving by older drivers). Yet little is known about how older drivers behave, or how middle-aged versus teen drivers behave at intersections.
- **While some limited experimental work has been done on this topic, few or no studies based on *naturalistic* driving data have been reported in the literature. Thus, it is important to know if experimental findings are replicated in naturalistic driving:**
 - Bao & Boyle (2009), in an on-road experiment on rural roads, found that older drivers exhibited narrower visual scans after initiating left turns.
 - Fildes et al (2006), in simulator studies, found age-related differences in scan patterns to hazards.

DATA MINING ALGORITHM

- **Intersections of Unprotected Nature were identified** and made sure that there was data available for all participant groups
 - **One Signalized Intersection** where left turns made under the **Yield Signal**
 - **One Stop-sign Intersection** with a **One-Way Stop Sign** (placed on participant's side) was used. This Intersection was a **3-way intersection** where participant was turning (both **left & right**) into a **through-flowing traffic**
- **Coding of data from selected files**
 - Visual glances during turns were reduced by trained reductionists at VTTI
 - Presence of traffic was coded
 - Examination of gap behavior (for purpose of coding/analysis)